

ITEM	QTY	PART NO.	DESCRIPTION	ITEM	QTY	PART NO.	DESCRIPTION	ITEM	QTY	PART NO.	DESCRIPTION
1	150	101703	CS 7/16-14X3 GRBBB HXHD W/NEO	5	1	348181	DR TITAN INNER FLASHING PLATE	9	6	708206	NUT 5/16-18 HEX WHIZ FLNGE PLT
2	2	104757	TAPE PLS CLSD CELL.25WX1"TX20"	6	1	348509	BULLETIN 1230 DOOR,1 RING,COMMERC	10	3	716703	CAULK SILICONE GREY 100Z
3	6	348152	BN TITAN STIFF SHIM 14GA	7	6FT	487118	TAPE PLASTIC FOAM 1/8X3/4	11	6	820597	CS 5/16-18X.75 TRUSS HD PLTD
4	2	348154	DR TITAN STIFF ENDCAP LARGE	8	180	501635	NUT 7/16-14 HEX WHIZ JS500PLTD	12	10	820878	CS 7/16-14X2 GRBBB HXHD W/NEO
								13	1	9381231	FLASHING,COMM DOOR,TOP

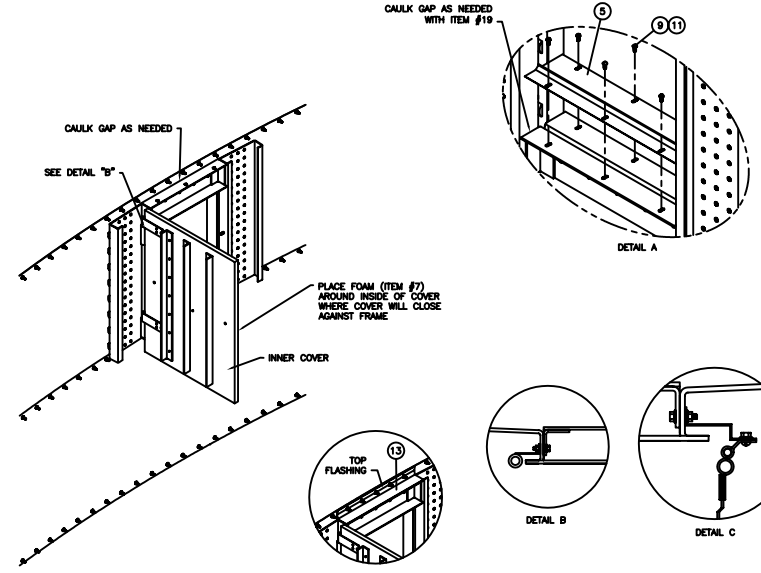
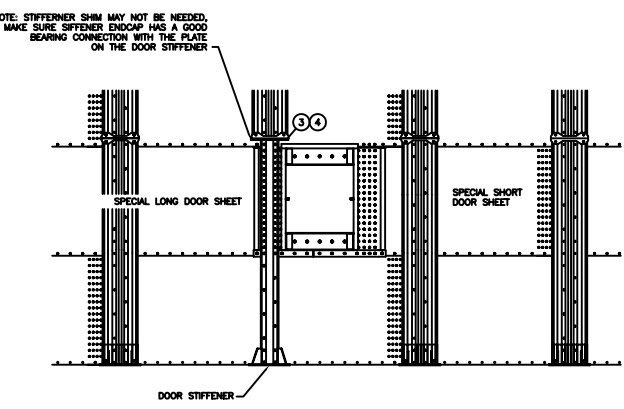
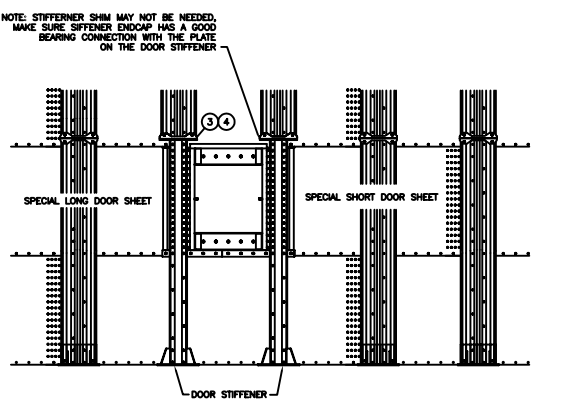
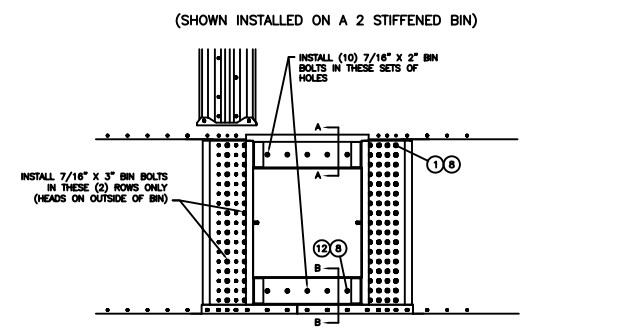
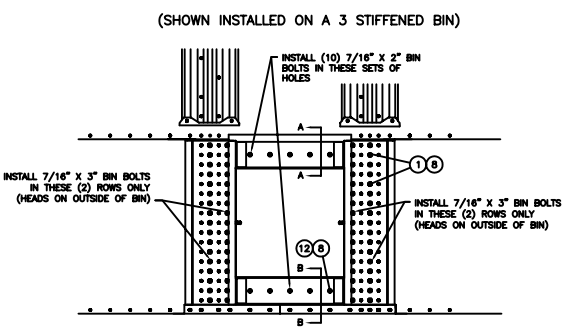
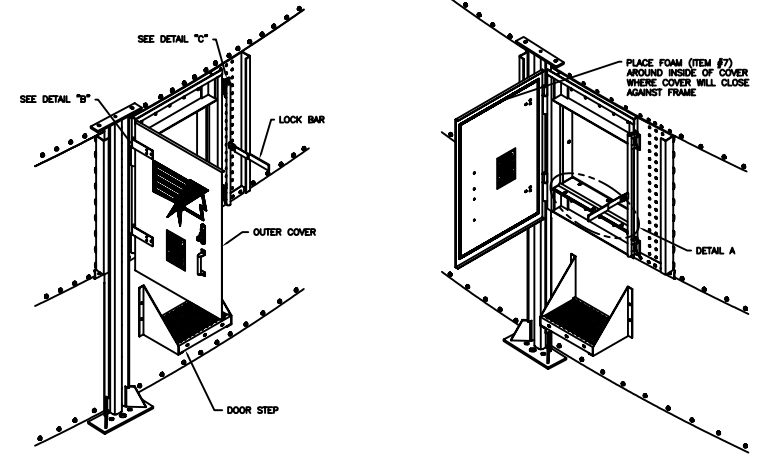
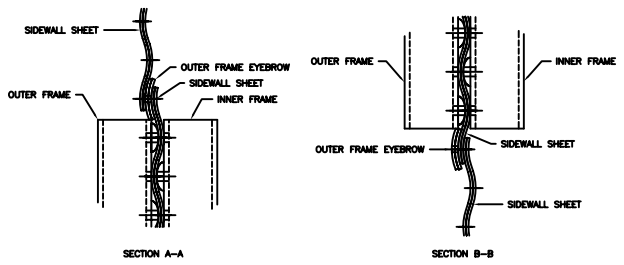
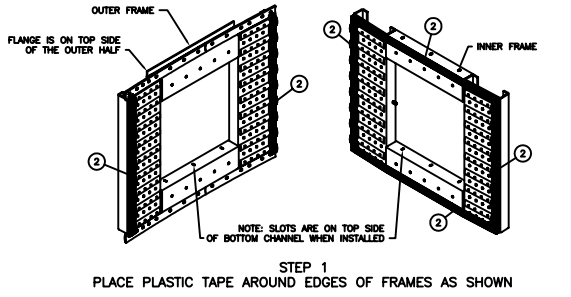

3 STIFFENED TANK

2 STIFFENED TANK

G		AUTODESIGN		PART NAME		BULLETIN 1230 DOOR,1 RING,COMMERCIAL	
B		BY DATE		DATE		102-27-07	
A		CHECKED		APPROVED			
REVISED		TOLERANCES UNLESS OTHERWISE SPECIFIED		SIZE		SCALE	
DIMENSIONS -- 1/16"		FINISH -- 1/16"		D		1/16"=1'	
MATERIAL		THIS DRAWING AND ALL INFORMATION HEREON IS THE PROPERTY OF CHIEF AGRI/INDUSTRIAL, Keokuk, IOWA/USA		DRAWN		PART NO.	
		IT IS LOANED CONFIDENTIALLY AND MUST NOT BE USED IN ANY WAY BEYOND THAT OF CHIEF INDUSTRIES INC.		DATE		(C910) 349509	