

ITEM	QTY	PART NO.	DESCRIPTION	ITEM	QTY	PART NO.	DESCRIPTION
1	350	101703	BOLT,HHBB,7/16"-14X3.0,GR8	8	10	820878	BOLT,HHBB,7/16"-14X2.0,GR8
2	2	104757	SEALANT,TAPE,PLST FM.,1.25X1X20'	9	1	9346161	DR TITAN INNER FLASHING PLATE
3	6	467118	SEALANT,TAPE,PLST FM.,1.25X.750	10	1	9381231	FLASHING,COMM DOOR,TOP
4	360	501635	NUT,7/16-14,HEX-WHIZFLNG,JS500	11	6	9346152	BN TITAN STIFF SHIM 14GA
5	25	708206	NUT,5/16-18,HEX-WHIZFLNG,JS500	12	2	9346154	DR TITAN STIFF ENDCAP LARGE
6	3	716703	SEALANT,CAULK,SILICONE,GRY,100Z	13	4	9349666	DOOR,2 RING,STIFF SPACER
7	25	820597	BOLT,THCS,5/16-18X0.750,PLTD	14	28	9341000	SHIM,DOOR STIFF,8GA

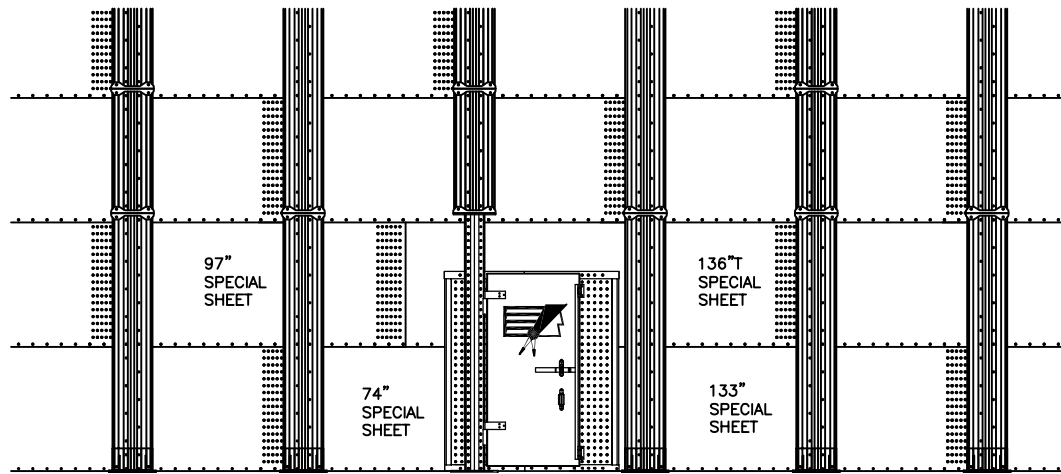

2 STIFFENERS PER SIDEWALL SHEET

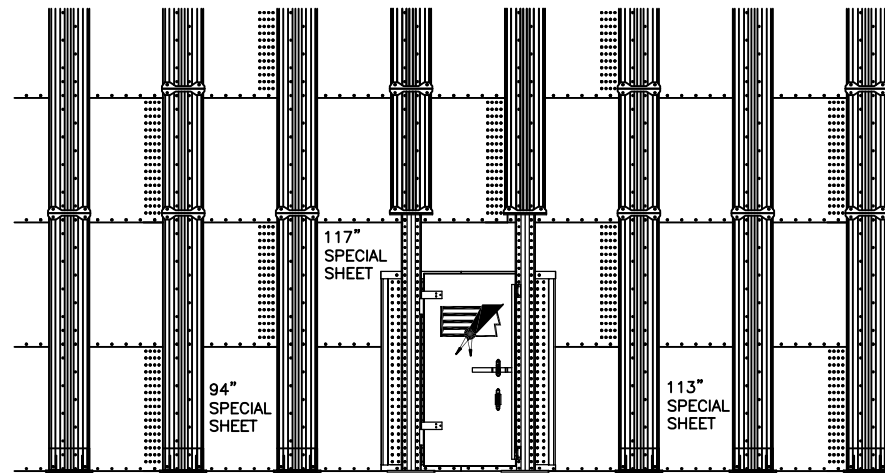

3 STIFFENERS PER SIDEWALL SHEET

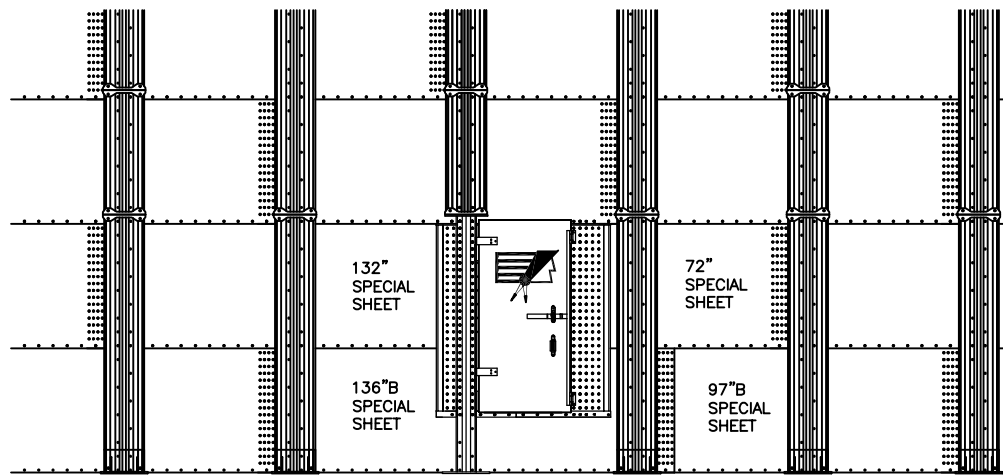

2 STIFFENERS PER SIDEWALL SHEET

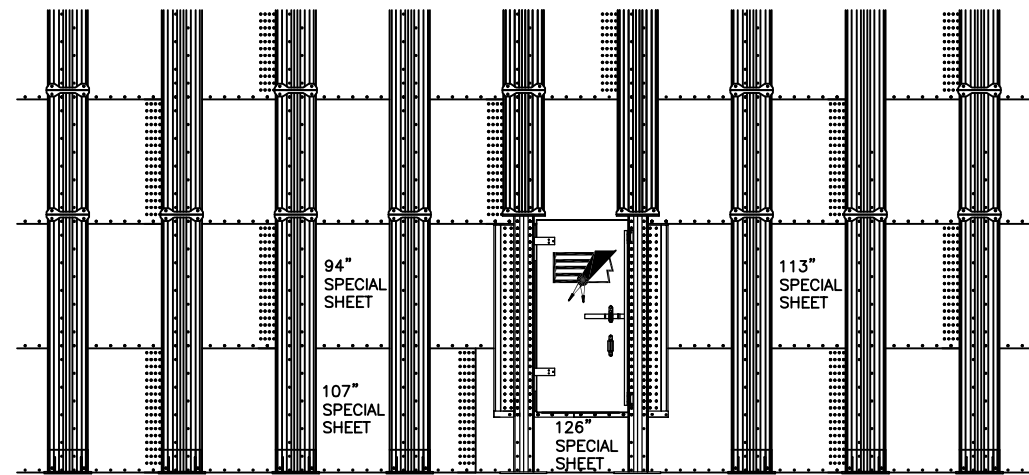

3 STIFFENERS PER SIDEWALL SHEET

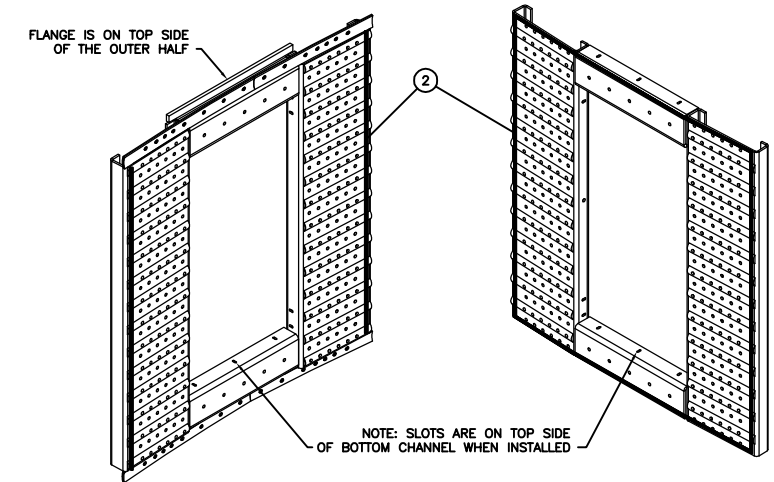

PLACE FOAM AROUND EDGES OF FRAMES AS SHOWN

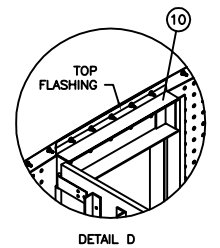
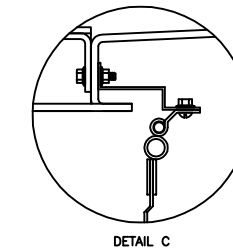
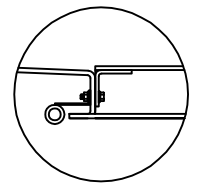
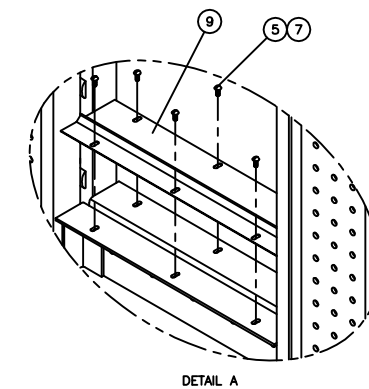
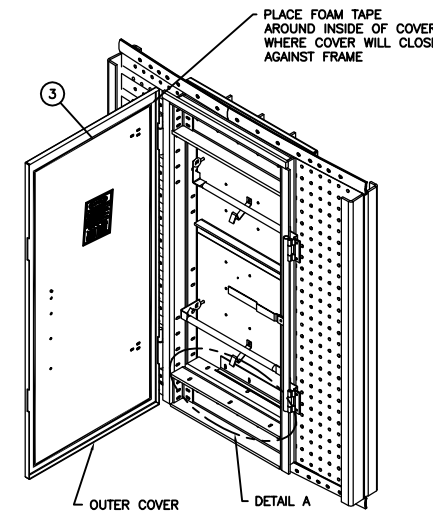
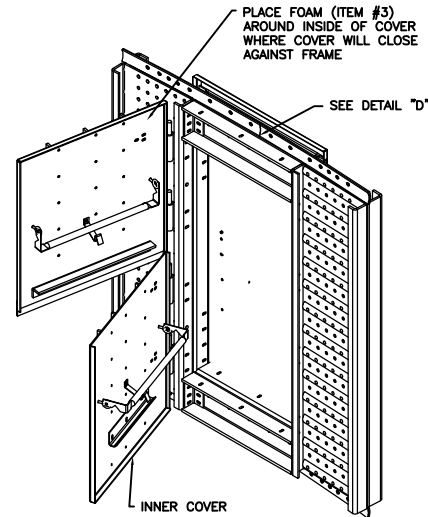
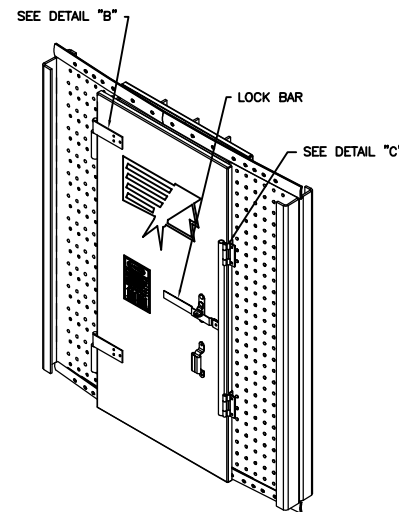
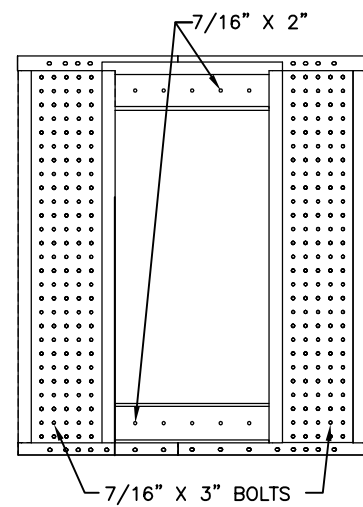
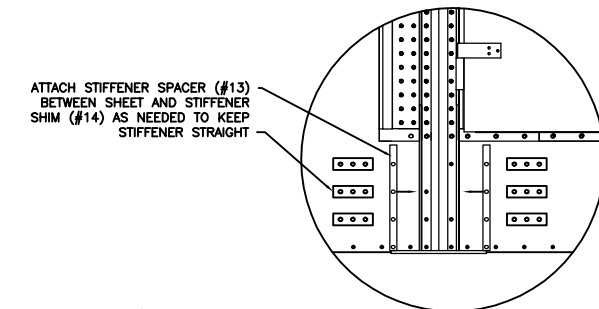

ECCO NO.		BY	DATE	REVISIONS	TOLERANCES UNLESS OTHERWISE SPECIFIED FRACTIONS -- 1/32 DECIMALS -- .031 ANGLES -- 1/4	DIMENSIONS IN BRACKETS [] ARE METRIC EQUIVALENTS	THE DESIGN AND ALL DIMENSIONS ARE THE PROPERTY OF CHEF INDUSTRIES, INC. CONFIDENTIAL AND NOT TO BE REPRODUCED OR USED IN ANY MANNER WITHOUT THE WRITTEN PERMISSION OF CHEF INDUSTRIES, INC.	FIN.M.T.	DWG/PART NAME:	MANUAL,2 RING DOOR,COMMERCIAL	BY	DATE	SIZE	DWG/PART NO.:
													D	381545
												12-04-08	SCALE:	NA