

Airframe Support Full Floors

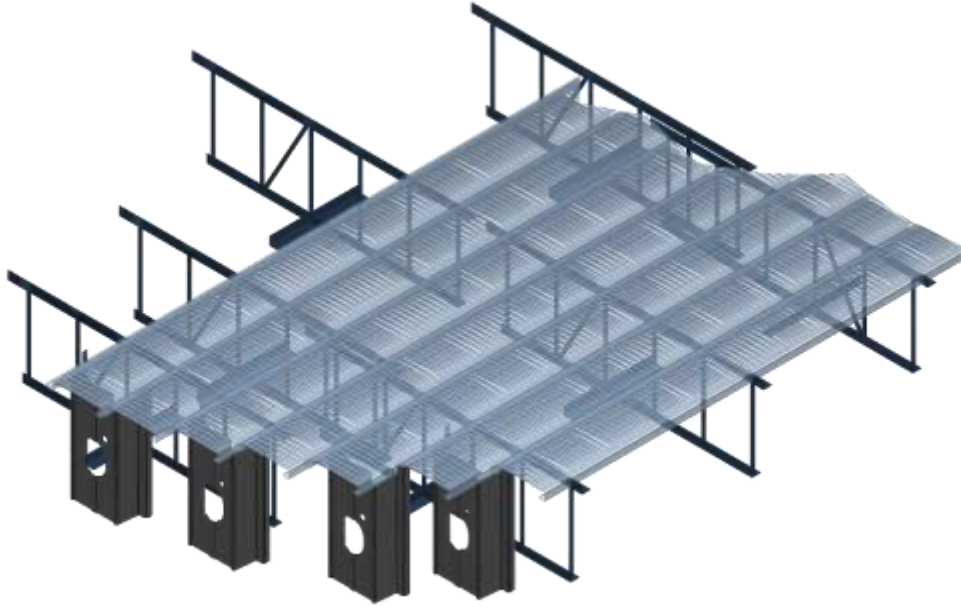

INSTALLATION MANUAL

P/N 762947 Rev 0

CHIEF
AGRI

Trusted. Tested. True.®

Installation Manual



This symbol means “Attention! Be Alert! Your Safety Is At Stake!”

The safety alert symbol identifies safety messages. Verify you are familiar with the messages identified for you with the safety alert symbol. When you see this symbol, be alert to the possibility of serious injury or death. Follow the safety instructions given in this manual.

Danger: Indicates an imminently hazardous situation which, if not avoided, will result in death or serious injury.

Warning: Indicates a potentially hazardous situation which, if not avoided, could result in death or serious injury and property damage.

Caution: Indicates a potentially hazardous situation which, if not avoided, may result in minor or moderate injury. It may also be used to alert against unsafe practices.



WARNING: Improper installation, adjustment, alteration, service or maintenance can cause property damage, injury or death. Read the installation, operating and maintenance instructions thoroughly before installing or servicing this equipment.

© Chief Industries, Inc.
4400 East 39th Street • PO Box 848
Kearney, NE 68847
Phone 800.359.7600

For more information about Chief Industries, Inc. and additional products or services please visit our website
www.agri.chiefind.com

Table of Contents

Introduction	4
Model Number Description.....	4
Packing List.....	4
Before You Begin	5
Safety and Precautions	5
Assembly Instructions	7
STANDARD LIMITED WARRANTY.....	13

Introduction

Thank you for purchasing a Caldwell airframe support aeration floor. Proper installation will ensure you the best overall experience with your aeration floor and guarantee smooth operation. This manual is for the installation of the Caldwell airframe support aeration floor.

This proprietary information is loaned with the expressed agreement that the drawings and information therein contained are the property of Chief Industries, Inc. and will not be reproduced, copied, or otherwise disposed of, directly or indirectly, and will not be used in whole or in part to assist in making or to furnish any information for the making of drawings, prints or other reproduction hereof, or for the making of additional products or equipment except upon written permission of Chief Industries, Inc. first obtained and specific as to each case. The acceptance of this material will be construed as an acceptance of the foregoing agreement.

The technical data contained herein is the most recent available at the time of publication and is subject to modification without notice. Chief Industries, Inc. reserves the right to modify the construction and method of operation of their products at any time without any obligation on their part to modify any equipment previously sold and delivered.

Model Number Description

The floor model nomenclature includes a designation of the applicable bin diameter. The definition of the model number nomenclature is as follows:

Example: CLF 2710

(a) (b)

- (a) CLF = Channel Lock Floor
 Where: CLF = Channellock floor
 CLFS= Channellock floor split
- (b) 2710 = Bin Diameter
 Where: 2710 = 27'-10" (8.48m)

Packing List

Verify and inspect all items carefully when unpacking and before installing. In case of any shortage, contact your dealer. In case of damage during shipment, file a claim with the carrier.

Note: Installation of full floor references bulletin 1051 and is effective 5/1/2015.



Before You Begin

Read this manual thoroughly before installing the airframe support for a full floor. Keep this manual in a location for quick access and reference.

Chief will not be responsible for damage resulting from improper storage, handling prior to installation or improper installation of products.

The Chief full floor warranty is valid only when supported by chief airframe support steel supports.

A flat concrete surface is required to allow proper installation of the full floor. A 1/2" (1.27cm) variation from grade over a span of half the concrete slab diameter, with no abrupt irregularities of contour is required. A concave or convex floor voids the warranty.

When a sweep auger will be installed on the full floor verify:

- The sweep auger contact wheels (drive and idler wheels) do not apply a point force to the floor. Consult the sweep auger manufacturer for a drive track if required.
- Do not use a single pass sweep auger for 60' (18.29m) diameter or larger bins.

Safety and Precautions

Your safety and the safety of others is a primary concern to Chief Industries, Inc. This manual was written to assist in the safe installation and operation of the Caldwell airframe support aeration floor.

It is your responsibility as the owner, builder, operator, or supervisor to know what specific requirements, precautions and hazards exist and to make these known to all personnel working with equipment or on the jobsite so that they can observe any necessary safety precautions.

All personnel, including the installation crew, must read and understand the information contained in this manual before starting construction. Chief Industries, Inc. is not responsible or liable for the misuse of equipment or operation of personnel or equipment in an unsafe manner.

Chief Industries, Inc. assumes no liability with respect to proper construction and inspection, assembly, or use of its products established under applicable laws, all of which is the sole responsibility of the purchaser and those authorized for the installation.

Follow all local and federal safety laws and regulations. Verify that all equipment and personnel conform to any applicable jurisdiction regulations.

Operation Safety

Heed the following warning:

DANGER

YOU CAN SUFFOCATE UNDER
GRAIN IN THIS BIN

DO NOT ENTER WHEN THIS BIN IS BEING LOADED OR UNLOADED.

— IF YOU MUST ENTER THE BIN —

1. SHUT OFF AND LOCK OUT ALL POWER.
2. USE A SAFETY HARNESS AND SAFETY LINE.
3. WEAR A DUST RESPIRATOR.
4. AVOID THE CENTER OF THE BIN.
5. STATION A PERSON TO HELP FROM OUTSIDE THE BIN.

— THE DANGER IS FROM —

FLOWING GRAIN



FLOWING GRAIN TRAPS AND SUFFOCATES

AND

— THE DANGER IS FROM —

CRUSTED GRAIN



CRUSTED GRAIN COLLAPSES AND SUFFOCATES

872044

Assembly Instructions

The Caldwell airframe support is designed to span six channel lock planks when installed. The airframe support is manufactured as a straight support for ease of installation. Standard Caldwell stamped supports are used in two situations, at the end of required planks, and where two floor planks come together to make a splice.

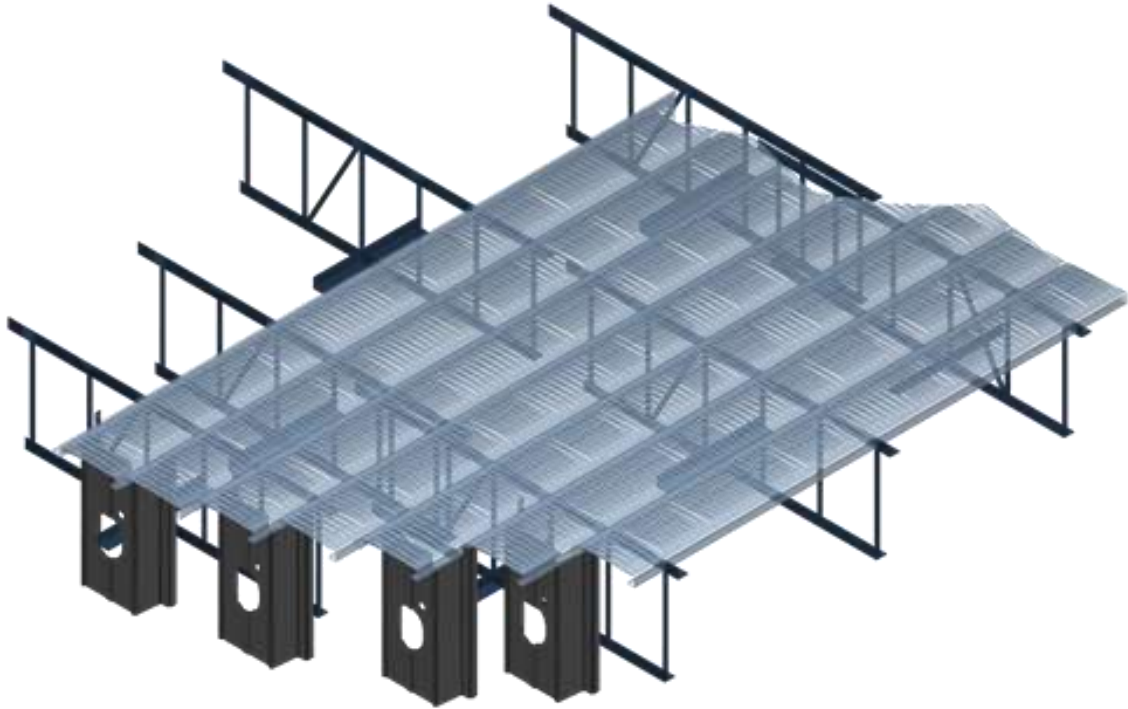

First use the packing list in the full floor bolt bag assembly to verify all floor component parts are present and quantities are correct. Next review the floor support layout for your installation that is based upon the bin diameter, maximum peak grain depth and type of aeration floor (1 piece or split floor). **Note:** For bins 33'-42' (10.05m-12.80m) diameter, floors may be purchased as 1-piece or split floor.

Study the layout of the floor assembly to determine proper position of the floor planks with respect to the unloading auger and transition. The following illustration describes key features of the aeration floor.

- The unloading auger should run perpendicular to the floor planks.
- The transition should be 180 degrees from the unloading auger discharge.
 - For two fans on the bin locate one fan to the left of the centerline of the bin and the second fan to the right of the centerline of the bin

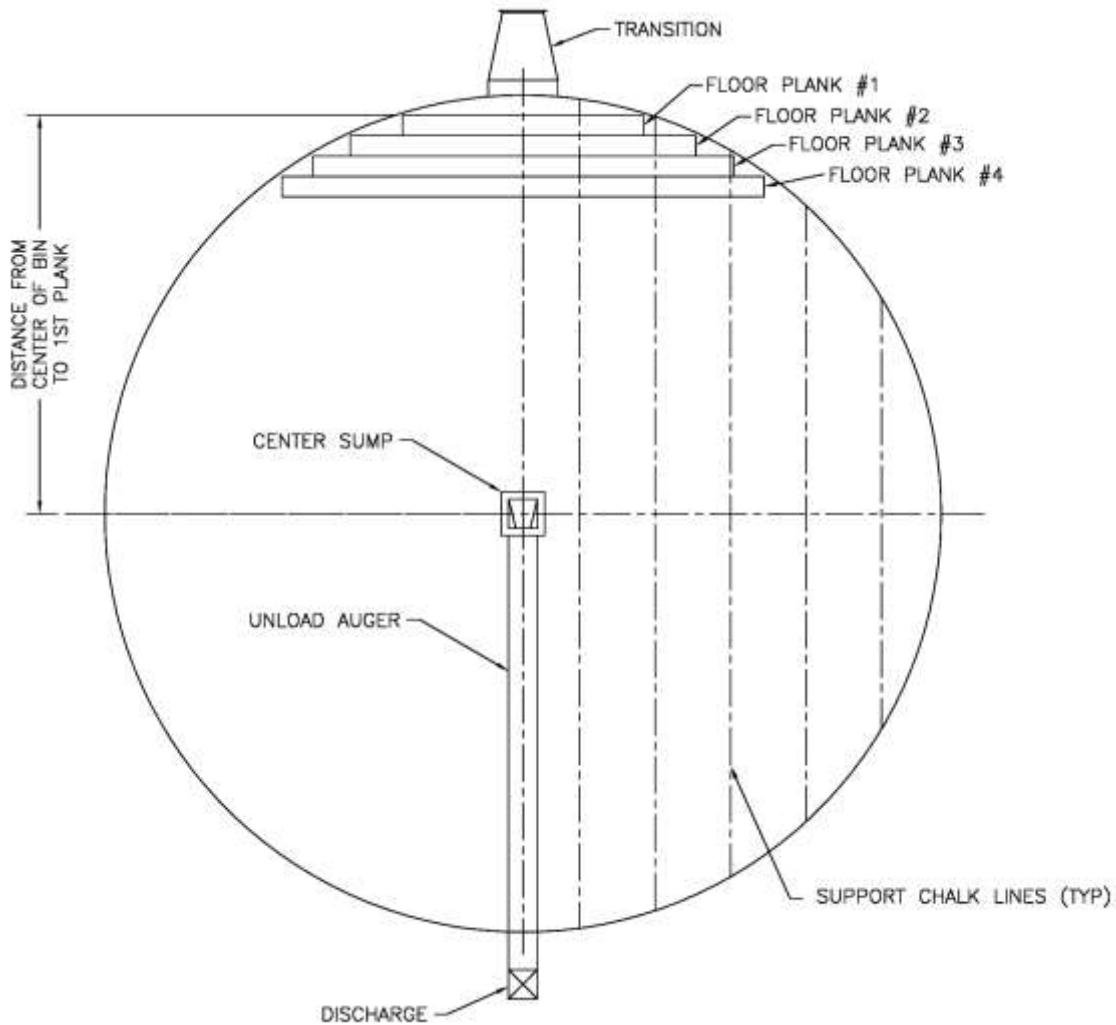

Locate the center of the bin. Chalk a line on the same centerline as the unloading auger. Refer to the appropriate floor support layout and create chalk lines on the concrete floor parallel to the bin centerline at the specified locations for the floor supports.

Using the support spacing listed, divide the spacing in half and run a chalk line "1/2 Spacing" to the left and the right of the bin centerline. **Note:** The chalk line establishes the location of the first row of Airframe supports.

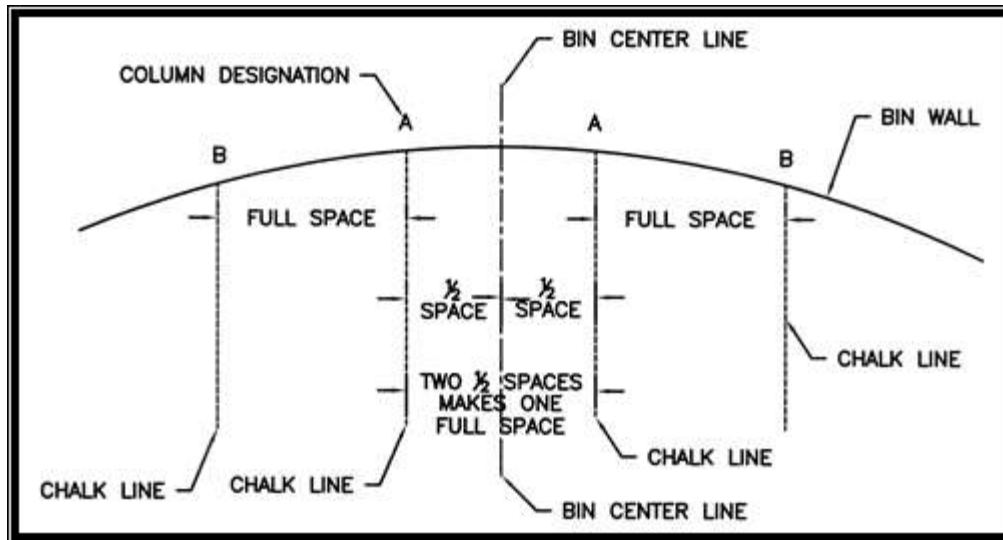

For each half of the bin run additional chalk lines incrementally at the support full spacing dimension. The second location is labeled Column "B". The airframe support column locations continue until the last "alpha" character has had a chalk line established.

With all airframe locations established on the floor of the bin, proceed with installation of the floor. The airframe support spans six consecutive channel lock planks. The “[]” character in each airframe column, identifies the channel lock row for that particular airframe column that requires an airframe support. With the airframes positioned in the bin for the first channel lock row locate the back of the channel lock plank at the designated distance from the center of the bin. Per column labeled “End Stamped Support” add a stamped support at 4” from the ends of the plank, if end supports are required.

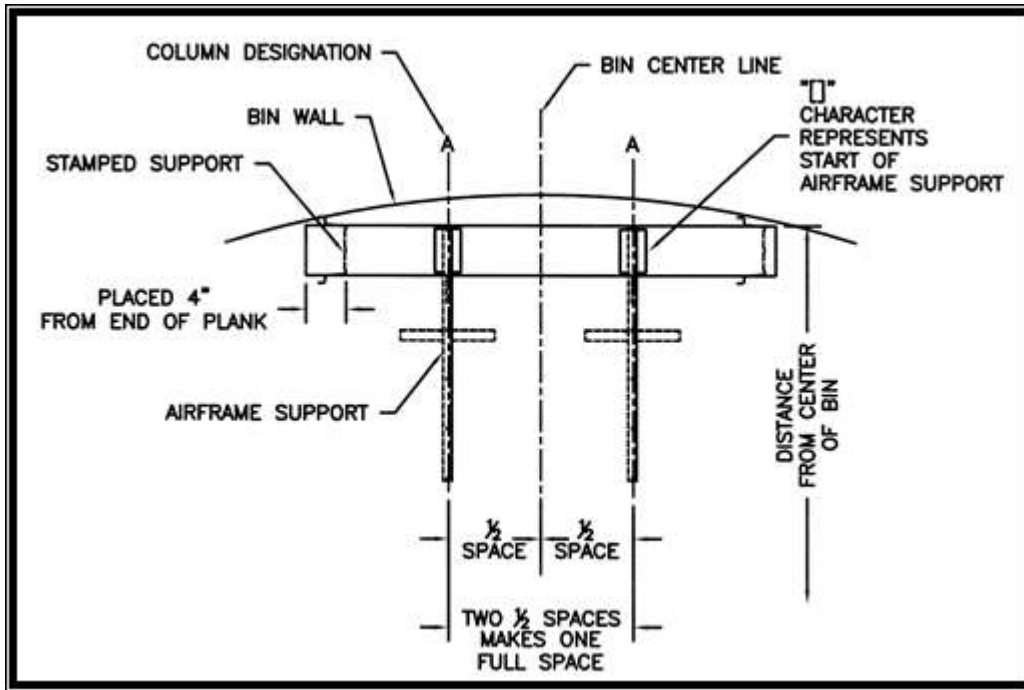

Continue to add airframe support columns and channel lock rows per bulletin 1050-A. The “[]” character specifies the starting position of every Airframe support to be added. Continue to add stamped supports to the end of channel lock rows at a distance of 4” when required, and add a stamped support at splice locations for split floors.

The airframe support locations are specified such that no airframe support requires field modification to cover fewer channel lock rows. Therefore, the last pair of airframe supports in any particular column may overlap the spacing of the previous airframe support. Where this condition is present locate the airframe supports side by side for the lengths of the airframe support that overlap. If the stabilizer foot will interfere with the previous Airframe support, turn the support 180 degrees. When installing the last airframe supports in any column, verify that the last pair of Airframe supports are started under the proper rows. (Note that the last airframe support will support 5 channel lock planks.)

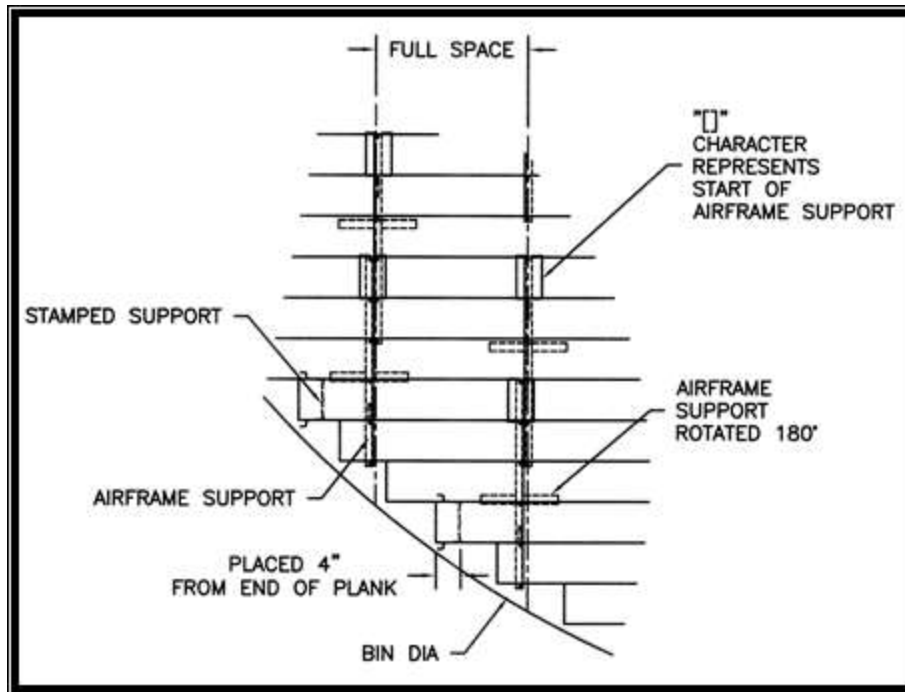

The overlap detail is shown in the following illustration.

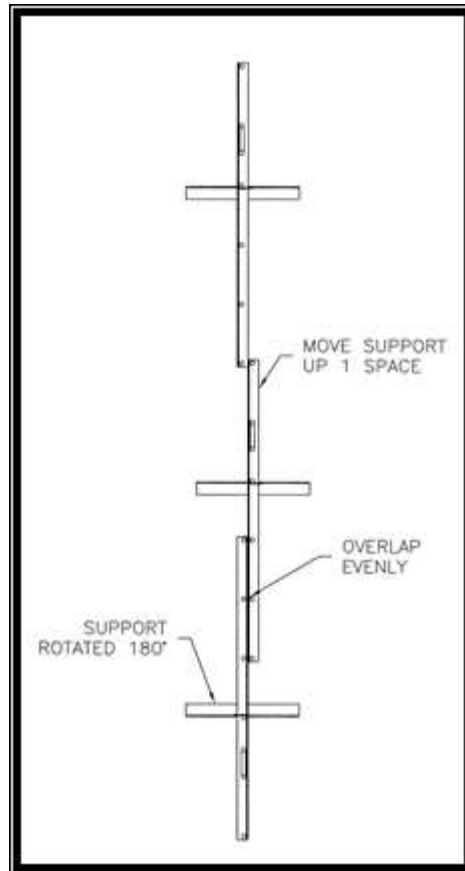

STANDARD LIMITED WARRANTY

Caldwell Aeration Products

1. **Definitions.** The following terms, when they appear in the body of this Standard Limited Warranty for Caldwell Aeration Products in initial capital letters shall have the meaning set forth below:
 - A. Accepted Purchase Order shall mean the Purchase Order identified below.
 - B. Chief shall mean Chief Agri/Industrial, a division of Chief Industries, Inc.
 - C. Original Owner shall mean the original owner identified below.
 - D. Product shall mean the Agri/Industrial Equipment as described in the Accepted Purchase Order.
 - E. Reseller shall mean the authorized Chief Agri/Industrial Equipment dealer identified below.

2. **Limited Product Warranty.** Upon and subject to the terms and conditions set forth below, Chief hereby warrants to the Reseller, and, if different, the Original Owner as follows:
 - A. All new Products delivered to the Reseller or the Original Owner by Chief pursuant to the Accepted Purchase Order will, when delivered, conform to the specifications set forth in the Accepted Purchase Order;
 - B. All new Products delivered pursuant to the Accepted Purchase Order will, in normal use and service, be free from defects in materials or workmanship; and
 - C. Upon delivery, Chief will convey good and marketable title to the Products, free and clear of any liens or encumbrances except for, where applicable, a purchase money security interest in favor of Chief.

3. **Duration of Warranty and Notice Requirements.** Subject to the **Exceptions, Exclusions and Limitations** set forth below, the warranties set forth in Section 2 above shall apply to all covered non-conforming conditions that are discovered within the first twenty-four (24) months following delivery of the Product to the carrier designated by the Reseller and/or the Original Owner at Chief's manufacturing facility in Kearney, Nebraska (the "Warranty Period") and are reported to the Chief as provided in Section 4 below within thirty (30) days following discovery (a "Notice Period").

4. **Notice Procedure.** In order to make a valid warranty claim, the Reseller and/or the Original Owner must provide Chief with a written notice of any nonconforming condition discovered during the Warranty Period within the applicable Notice Period specified in Section 3 above. Said notice must be in writing; be addressed to Chief Industries, Inc., Agri/Industrial Division, Customer Service Department, P.O. Box 848, Kearney, NE 68848; and contain the following information: (a) the Customer's name and address; (b) the Reseller's name and address; (c) the make and model of the Product in question; (d) the current location of the Product; (e) a brief description of the problem with respect to which warranty coverage is claimed; and (f) the date on which the Product was purchased.

5. **Exceptions and Exclusions.** Anything herein to the contrary notwithstanding, the warranties set forth in Section 2 above do **not** cover any of the following, each of which are hereby expressly excluded:

- A. Defects that are not discovered during the applicable Warranty Period;
- B. Defects that are not reported to the Chief Agri/Industrial Division Customer Service Department in conformity with the notice procedure set forth in Section 4 above within the applicable Notice Period specified in Section 3;
- C. Any used or pre-owned Products;
- D. Any Chief manufactured parts that are not furnished as a part of the Accepted Purchase Order;
- E. Any fixtures, equipment, materials, supplies, accessories, parts or components that have been furnished by Chief but are manufactured by a third party;
- F. Any Products which have been removed from the location at which they were originally installed;
- G. Any defect, loss, damage, cost or expense incurred by the Reseller or the Original Owner to the extent the same arise out of, relate to or result, in whole or in part, from any one or more of the following:
 - (i) Usual and customary deterioration, wear or tear resulting from normal use, service and exposure;
 - (ii) Theft, vandalism, accident, war, insurrection, fire or other casualty;
 - (iii) Any damage, shortages or missing parts which result during shipping or are otherwise caused by the Reseller, the Original Owner and/or any third party;
 - (iv) Exposure to marine environments, including frequent or sustained salt or fresh water spray;
 - (v) Exposure to corrosive, chemical, ash, smoke, fumes, or the like generated or released either within or outside of the structure on which the Product is installed, regardless of whether or not such facilities are owned or operated by the Reseller, the Original Owner or an unrelated third party;
 - (vi) Exposure to or contact with animals, animal waste and/or decomposition;
 - (vii) The effect or influence the Product may have on surrounding structures, including, without limitation, any loss, damage or expense caused by drifting snow;
 - (viii) Any Product or portion thereof that has been altered, modified or repaired by the Reseller, the Original Owner or any third party without Chief's prior written consent;
 - (ix) Any Product or portion thereof that has been attached to any adjacent structure without Chief's prior written approval;
 - (x) Any Product to which any fixtures, equipment, accessories, materials, parts or components which were not provided as a part of the original Accepted Purchase Order have been attached without Chief's prior written approval;
 - (xi) The failure on the part of the Reseller, the Original Owner or its or their third party contractors to satisfy the requirements of all applicable statutes, laws, ordinances rules, regulations and codes, (including zoning laws and/or building codes);
 - (xii) The use of the Product for any purpose other than the purpose for which it was designed; and/or
 - (xiii) The failure of the Reseller, the Original Owner and/or any third party to:
 - (a) properly handle, transport and/or store the Product or any component part thereof;

- (b) properly select and prepare a site that is adequate for the installation and/or operation of the Product or any component part thereof;
- (c) properly design and construct a foundation that is adequate for the installation and/or operation of the Product or any component part thereof;
- (d) properly set up, erect, construct or install the Product and/or any component part thereof; and/or
- (e) properly operate, use, service and/or maintain the Product and each component part thereof.

6. **Resolution of Warranty Claims.** In the event any nonconforming condition is discovered within the Warranty Period and Chief is notified of a warranty claim as required by Section 4 prior to the end of the applicable Notice Period set forth in Section 3 above, Chief shall, with the full cooperation of the Reseller and the Original Owner, immediately undertake an investigation of such claim. To the extent Chief shall determine, in its reasonable discretion, that the warranty claim is covered by the foregoing Limited Product Warranty, the following shall apply:

- A. Warranty Claims With Respect to Covered Non-Conforming Conditions Discovered Within the First Three Hundred Sixty Five (365) Days and Reported to Chief Within Thirty (30) Days of Discovery. In the case of a warranty claim which relates to a covered non-conforming condition that is discovered during the first three hundred sixty five (365) days of the Warranty Period and is reported to Chief as required by Section 4 within thirty (30) days of discovery as required by Section 3, Chief will, as Chief's sole and exclusive obligation to the Reseller and the Original Owner, and as their sole and exclusive remedy, work in cooperation with the Reseller and the Original Owner to correct such non-conforming condition, and in connection therewith, Chief will ship any required replacement parts to the "ship to address" set forth in the Accepted Purchase Order FOB Chief's facilities in Kearney, Nebraska, and will either provide the labor or reimburse the Reseller or the Original Owner, as may be appropriate in the circumstances, for any out of pocket expense the Original Owner may reasonably and necessarily incur for the labor that is required to correct such non-conforming condition, provided that if work is to be performed by the Reseller or a third party contractor, Chief may require at least two competitive bids to perform the labor required to repair or correct the defect and reserves the right to reject all bids and obtain additional bids. Upon acceptance of a bid by Chief, Chief will authorize the necessary repairs.
- B. All Other Warranty Claims. Except as is otherwise provided in subsection 6A above, in the case of all other warranty claims which relate to covered non-conforming conditions that are discovered during the Warranty Period and are reported to Chief as required by Section 4 within thirty (30) days following discovery, Chief will, as Chief's sole and exclusive obligation to the Reseller and the Original Owner, and as the Reseller's and the Original Owner's sole and exclusive remedy, ship any required replacement parts to the Original Owner at the "ship to address" specified in the Accepted Purchase Order FOB Chief's facilities in Kearney, Nebraska; and **in such event, Chief shall have no responsibility or liability to either the Reseller or the Original Owner for the cost of any labor required to repair or correct the defect.**

7. **Warranty Not Transferable.** This Warranty applies only to the Reseller and the Original Owner and is **not transferable**. As such, this Warranty does **not** cover any Product that is sold or otherwise transferred to any third party following its delivery to the Original Owner.
8. **Limitation on Warranties, Liabilities and Damages.** The Reseller and the Original Owner expressly agree that the allocation of the risk, liability, loss, damage, cost and expense arising from any Product that does not conform to the limited warranty given in Section 2 above are fair and reasonable and acknowledge that such allocation was expressly negotiated by the parties and was reflected in the Purchase Price of the Product. Accordingly the Reseller and the Original Owner expressly agree as follows:
- A. **Disclaimer of Implied Warranties.** EXCEPT AS IS OTHERWISE EXPRESSLY SET FORTH HEREIN, CHIEF MAKES NO OTHER REPRESENTATIONS OR WARRANTIES OF ANY KIND WHATSOEVER, WHETHER EXPRESS OR IMPLIED, BY OPERATION OF LAW, COURSE OF DEALING OR OTHERWISE WITH RESPECT TO THE PRODUCT, ANY COMPONENT PART THEREOF OR ANY OTHER GOODS OR SERVICES THAT CHIEF MANUFACTURES, FABRICATES, PRODUCES, SELLS OR PROVIDES TO THE DEALER OR THE ORIGINAL OWNER PURSUANT TO THE TERMS OF ANY ACCEPTED PURCHASE ORDER, INCLUDING WITHOUT LIMITATION ANY REPRESENTATION OR WARRANTY WITH RESPECT TO DESIGN, CONDITION, MERCHANTABILITY OR FITNESS OF THE PRODUCT OR ANY OTHER GOODS OR SERVICES FOR ANY PARTICULAR PURPOSE OR USE.
- B. **Limitation on Liability.** EXCEPT AS IS OTHERWISE EXPRESSLY SET FORTH IN SECTION 6 ABOVE, CHIEF'S LIABILITY TO THE DEALER AND/OR THE ORIGINAL OWNER WITH RESPECT TO ANY DEFECTS IN ANY PRODUCTS OR FOR ANY OTHER GOODS OR SERVICES WHICH DO NOT CONFORM TO THE WARRANTIES SET FORTH ABOVE SHALL NOT, IN ANY EVENT, EXCEED THE ACTUAL COST OF SUCH NON-CONFORMING PRODUCT, GOODS OR SERVICES AS DETERMINED PURSUANT TO THE ACCEPTED PURCHASE ORDER; AND
- C. **Limitation on the Nature of Damages.** EXCEPT AS EXPRESSLY PROVIDED IN SECTION 6 ABOVE, CHIEF SHALL NOT, UNDER ANY CIRCUMSTANCES, BE LIABLE TO THE DEALER, THE ORIGINAL OWNER OR ANY THIRD PARTY FOR ATTORNEY FEES COURT COSTS OR ANY OTHER SPECIAL, INDIRECT, INCIDENTAL, CONSEQUENTIAL, LIQUIDATED OR PUNITIVE DAMAGES OF ANY NAME, NATURE OR DESCRIPTION AS A RESULT OF THE FAILURE OF ANY PRODUCT OR ANY OTHER GOODS OR SERVICES PURCHASED BY THE DEALER OR THE ORIGINAL OWNER FROM CHIEF PURSUANT TO THE ACCEPTED PURCHASE ORDER TO CONFORM TO THE LIMITED WARRANTIES SET FORTH IN SECTION 2 ABOVE.
8. **Applicable Law.** This Limited Product Warranty has been issued, accepted and entered into by the Reseller, the Original Owner and Chief in the State of Nebraska and shall be governed by, and construed in accordance with, the internal laws of the State of Nebraska. Any legal action

or proceeding with respect to any goods or services furnished to the Original Owner by Chief in connection herewith, or any document related hereto shall be brought only in the district courts of Nebraska, or the United States District Court for the District of Nebraska, and, by execution and delivery of this Limited Product Warranty, the undersigned Original Owner hereby accept for themselves and with respect to their property, generally and unconditionally, the jurisdiction of the aforesaid courts. Further, the undersigned Original Owner hereby irrevocably waives any objection, including, without limitation, any *forum non conveniens*, which it may now or hereafter have to the bringing of such action or proceeding in such respective jurisdictions.

ACKNOWLEDGMENT OF RECEIPT

By its signature hereto, the undersigned Reseller represents and warrants to Chief that the Reseller has provided a true, correct and complete copy of this Standard Limited Warranty to the Original Owner at the time the product was purchased.

Reseller Name and Address: _____

Original Owner Name and Address: _____

Accepted Purchase Order No. _____

Original Jobsite Address: _____

RESELLER:

By: _____
Date

Print name and title

4821-6088-7329, v. 1

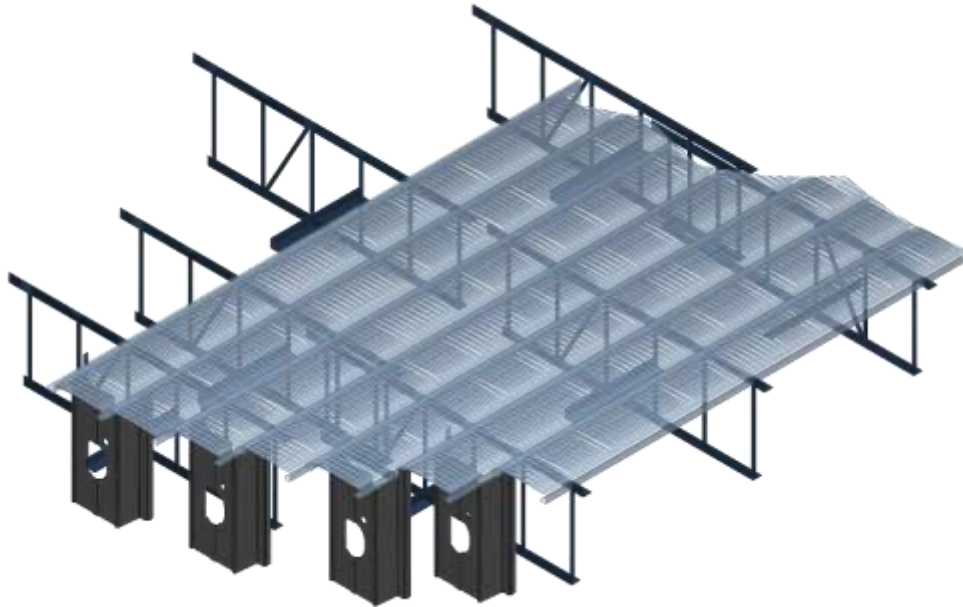

FULL FLOOR SYSTEMS

Should you have any questions concerning assembly instructions, parts or drawings, please feel free to contact us at any of the following.

© Chief Industries, Inc. Inc.
4400 East 39th Street • PO Box 848
Kearney, NE 68847
Phone 800.359.7600

For more information about Chief Industries, Inc. and additional products or services visit our website
www.agri.chiefind.com