

# TOWER INTERNAL PLATFORM



**INSTALLATION MANUAL**  
**P/N 621146**

**CHIEF** 

*Trusted. Tested. True.*

# Chief Industries, Inc. – Agri/Industrial Division

---

## Table of Contents

Manual Revisions .....	3
STANDARD LIMITED WARRANTY .....	4
Before You Begin .....	10
General Design Information.....	11
Accessory Equipment.....	12
General Contractor Responsibilities .....	12
Field Modifications and Installation Defects .....	12
Checking Shipment.....	12
Suggested Equipment .....	13
Hardware Torque.....	14
Installation .....	15
Part Identification .....	15
Platform Layouts.....	23
Installation.....	29
Elevator Leg Framing .....	38
Maintenance Instructions.....	39

## Manual Revisions

- 1-1-2016
  - General formatting update

© Chief Industries, Inc.  
4400 East 39<sup>th</sup> Street • PO Box 848  
Kearney, NE 68847  
Phone 800.359.7600

For more information about Chief Industries, Inc. and additional products or services please visit our website

[www.agri.Chiefind.com](http://www.agri.Chiefind.com)

## STANDARD LIMITED WARRANTY

### Catwalk and Tower Products

1. **Definitions.** The following terms, when they appear in the body of this Standard Limited Warranty for Catwalk and Tower Products in initial capital letters shall have the meaning set forth below:
  - A. Accepted Purchase Order shall mean the Purchase Order identified below.
  - B. Chief shall mean Chief Agri/Industrial, a division of Chief Industries, Inc.
  - C. Original Owner shall mean the original owner identified below.
  - D. Product shall mean the Agri/Industrial Equipment as described in the Accepted Purchase Order.
  - E. Reseller shall mean the authorized Chief Agri/Industrial Equipment dealer identified below.
2. **Limited Product Warranty.** Upon and subject to the terms and conditions set forth below, Chief hereby warrants to the Reseller, and, if different, the Original Owner as follows:
  - A. All new Products delivered to the Reseller or the Original Owner by Chief pursuant to the Accepted Purchase Order will, when delivered, conform to the specifications set forth in the Accepted Purchase Order;
  - B. All new Products delivered pursuant to the Accepted Purchase Order will, in normal use and service, be free from defects in materials or workmanship; and
  - C. Upon delivery, Chief will convey good and marketable title to the Products, free and clear of any liens or encumbrances except for, where applicable, a purchase money security interest in favor of Chief.
3. **Duration of Warranty and Notice Requirements.** Subject to the **Exceptions, Exclusions and Limitations** set forth below, the warranties set forth in Section 2 above shall apply to all covered non-conforming conditions that are discovered within the first twenty-four (24) months following delivery of the Product to the carrier designated by the Reseller and/or the Original Owner at Chief's manufacturing facility in Kearney, Nebraska (the "Warranty Period") and are reported to the Chief as provided in Section 4 below within thirty (30) days following discovery (a "Notice Period").
4. **Notice Procedure.** In order to make a valid warranty claim, the Reseller and/or the Original Owner must provide Chief with a written notice of any nonconforming condition discovered during the Warranty Period within the applicable Notice Period specified in Section 3 above. Said notice must be in writing; be addressed to Chief Industries, Inc., Agri/Industrial Division, Customer Service Department, P.O. Box 848, Kearney, NE 68848; and contain the following information: (a) the Customer's name and address; (b) the Reseller's name and address; (c) the make and model of the Product in question; (d) the current location of the Product; (e) a brief description of the problem with respect to which warranty coverage is claimed; and (f) the date on which the Product was purchased.

5. **Exceptions and Exclusions.** Anything herein to the contrary notwithstanding, the warranties set forth in Section 2 above do **not** cover any of the following, each of which are hereby expressly excluded:
- A. Defects that are not discovered during the applicable Warranty Period;
  - B. Defects that are not reported to the Chief Agri/Industrial Division Customer Service Department in conformity with the notice procedure set forth in Section 4 above within the applicable Notice Period specified in Section 3;
  - C. Any used or pre-owned Products;
  - D. Any Chief manufactured parts that are not furnished as a part of the Accepted Purchase Order;
  - E. Any fixtures, equipment, materials, supplies, accessories, parts or components that have been furnished by Chief but are manufactured by a third party;
  - F. Any Products which have been removed from the location at which they were originally installed;
  - G. Any defect, loss, damage, cost or expense incurred by the Reseller or the Original Owner to the extent the same arise out of, relate to or result, in whole or in part, from any one or more of the following:
    - (i) Usual and customary deterioration, wear or tear resulting from normal use, service and exposure;
    - (ii) Theft, vandalism, accident, war, insurrection, fire or other casualty;
    - (iii) Any damage, shortages or missing parts which result during shipping or are otherwise caused by the Reseller, the Original Owner and/or any third party;
    - (iv) Exposure to marine environments, including frequent or sustained salt or fresh water spray;
    - (v) Exposure to corrosive, chemical, ash, smoke, fumes, or the like generated or released either within or outside of the structure on which the Product is installed, regardless of whether or not such facilities are owned or operated by the Reseller, the Original Owner or an unrelated third party;
    - (vi) Exposure to or contact with animals, animal waste and/or decomposition;
    - (vii) The effect or influence the Product may have on surrounding structures, including, without limitation, any loss, damage or expense caused by drifting snow;
    - (viii) Any Product or portion thereof that has been altered, modified or repaired by the Reseller, the Original Owner or any third party without Chief's prior written consent;
    - (ix) Any Product or portion thereof that has been attached to any adjacent structure without Chief's prior written approval;
    - (x) Any Product to which any fixtures, equipment, accessories, materials, parts or components which were not provided as a part of the original Accepted Purchase Order have been attached without Chief's prior written approval;

- (xi) The failure on the part of the Reseller, the Original Owner or its or their third party contractors to satisfy the requirements of all applicable statutes, laws, ordinances rules, regulations and codes, (including zoning laws and/or building codes);
- (xii) The use of the Product for any purpose other than the purpose for which it was designed; and/or
- (xiii) The failure of the Reseller, the Original Owner and/or any third party to:
  - (a) properly handle, transport and/or store the Product or any component part thereof;
  - (b) properly select and prepare a site that is adequate for the installation and/or operation of the Product or any component part thereof;
  - (c) properly design and construct a foundation that is adequate for the installation and/or operation of the Product or any component part thereof;
  - (d) properly set up, erect, construct or install the Product and/or any component part thereof; and/or
  - (e) properly operate, use, service and/or maintain the Product and each component part thereof.

6. **Resolution of Warranty Claims.** In the event any nonconforming condition is discovered within the Warranty Period and Chief is notified of a warranty claim as required by Section 4 prior to the end of the applicable Notice Period set forth in Section 3 above, Chief shall, with the full cooperation of the Reseller and the Original Owner, immediately undertake an investigation of such claim. To the extent Chief shall determine, in its reasonable discretion, that the warranty claim is covered by the foregoing Limited Product Warranty, the following shall apply:

- A. **Warranty Claims With Respect to Covered Non-Conforming Conditions Discovered Within the First Three Hundred Sixty Five (365) Days and Reported to Chief Within Thirty (30) Days of Discovery.** In the case of a warranty claim which relates to a covered non-conforming condition that is discovered during the first three hundred sixty five (365) days of the Warranty Period and is reported to Chief as required by Section 4 within thirty (30) days of discovery as required by Section 3, Chief will, as Chief's sole and exclusive obligation to the Reseller and the Original Owner, and as their sole and exclusive remedy, work in cooperation with the Reseller and the Original Owner to correct such non-conforming condition, and in connection therewith, Chief will ship any required replacement parts to the "ship to address" set forth in the Accepted Purchase Order FOB Chief's facilities in Kearney, Nebraska, and will either provide the labor or reimburse the Reseller or the Original Owner, as may be appropriate in the circumstances, for any out of pocket expense the Original Owner may reasonably and necessarily incur for the labor that is required to correct such non-conforming condition, provided that if work is to be performed by the Reseller or a third party contractor, Chief may require at least two competitive bids to perform the labor required to repair or correct the defect and reserves the right to reject all bids and obtain additional bids. Upon acceptance of a bid by Chief, Chief will authorize the necessary repairs.
- B. **All Other Warranty Claims.** Except as is otherwise provided in subsection 6A above, in the case of all other warranty claims which relate to covered non-

conforming conditions that are discovered during the Warranty Period and are reported to Chief as required by Section 4 within thirty (30) days following discovery, Chief will, as Chief's sole and exclusive obligation to the Reseller and the Original Owner, and as the Reseller's and the Original Owner's sole and exclusive remedy, ship any required replacement parts to the Original Owner at the "ship to address" specified in the Accepted Purchase Order FOB Chief's facilities in Kearney, Nebraska; and in such event, Chief shall have no responsibility or liability to either the Reseller or the Original Owner for the cost of any labor required to repair or correct the defect.

7. **Warranty Not Transferable.** This Warranty applies only to the Reseller and the Original Owner and is **not transferable**. As such, this Warranty does not cover any Product that is sold or otherwise transferred to any third party following its delivery to the Original Owner.
8. **Limitation on Warranties, Liabilities and Damages.** The Reseller and the Original Owner expressly agree that the allocation of the risk, liability, loss, damage, cost and expense arising from any Product that does not conform to the limited warranty given in Section 2 above are fair and reasonable and acknowledge that such allocation was expressly negotiated by the parties and was reflected in the Purchase Price of the Product. Accordingly the Reseller and the Original Owner expressly agree as follows:
  - A. **Disclaimer of Implied Warranties.** EXCEPT AS IS OTHERWISE EXPRESSLY SET FORTH HEREIN, CHIEF MAKES NO OTHER REPRESENTATIONS OR WARRANTIES OF ANY KIND WHATSOEVER, WHETHER EXPRESS OR IMPLIED, BY OPERATION OF LAW, COURSE OF DEALING OR OTHERWISE WITH RESPECT TO THE PRODUCT, ANY COMPONENT PART THEREOF OR ANY OTHER GOODS OR SERVICES THAT CHIEF MANUFACTURES, FABRICATES, PRODUCES, SELLS OR PROVIDES TO THE DEALER OR THE ORIGINAL OWNER PURSUANT TO THE TERMS OF ANY ACCEPTED PURCHASE ORDER, INCLUDING WITHOUT LIMITATION ANY REPRESENTATION OR WARRANTY WITH RESPECT TO DESIGN, CONDITION, MERCHANTABILITY OR FITNESS OF THE PRODUCT OR ANY OTHER GOODS OR SERVICES FOR ANY PARTICULAR PURPOSE OR USE.
  - B. **Limitation on Liability.** EXCEPT AS IS OTHERWISE EXPRESSLY SET FORTH IN SECTION 6 ABOVE, CHIEF'S LIABILITY TO THE DEALER AND/OR THE ORIGINAL OWNER WITH RESPECT TO ANY DEFECTS IN ANY PRODUCTS OR FOR ANY OTHER GOODS OR SERVICES WHICH DO NOT CONFORM TO THE WARRANTIES SET FORTH ABOVE SHALL NOT, IN ANY EVENT, EXCEED THE ACTUAL COST OF SUCH NON-CONFORMING PRODUCT, GOODS OR SERVICES AS DETERMINED PURSUANT TO THE ACCEPTED PURCHASE ORDER; AND
  - C. **Limitation on the Nature of Damages.** EXCEPT AS EXPRESSLY PROVIDED IN SECTION 6 ABOVE, CHIEF SHALL NOT, UNDER ANY CIRCUMSTANCES, BE LIABLE TO THE DEALER, THE ORIGINAL OWNER OR ANY THIRD PARTY FOR ATTORNEY FEES COURT COSTS OR ANY OTHER SPECIAL, INDIRECT, INCIDENTAL, CONSEQUENTIAL, LIQUIDATED OR PUNITIVE DAMAGES OF ANY NAME, NATURE OR DESCRIPTION AS A RESULT OF THE FAILURE OF ANY PRODUCT OR ANY OTHER GOODS OR SERVICES PURCHASED BY THE DEALER OR THE ORIGINAL OWNER FROM CHIEF PURSUANT TO THE ACCEPTED PURCHASE ORDER TO CONFORM TO THE LIMITED WARRANTIES SET FORTH IN SECTION 2 ABOVE.

- 8. **Applicable Law.** This Limited Product Warranty has been issued, accepted and entered into by the Reseller, the Original Owner and Chief in the State of Nebraska and shall be governed by, and construed in accordance with, the internal laws of the State of Nebraska. Any legal action or proceeding with respect to any goods or services furnished to the Original Owner by Chief in connection herewith, or any document related hereto shall be brought only in the district courts of Nebraska, or the United States District Court for the District of Nebraska, and, by execution and delivery of this Limited Product Warranty, the undersigned Original Owner hereby accept for themselves and with respect to their property, generally and unconditionally, the jurisdiction of the aforesaid courts. Further, the undersigned Original Owner hereby irrevocably waives any objection, including, without limitation, any forum non conveniens, which it may now or hereafter have to the bringing of such action or proceeding in such respective jurisdictions.

**ACKNOWLEDGMENT OF RECEIPT**

By its signature hereto, the undersigned Reseller represents and warrants to Chief that the Reseller has provided a true, correct and complete copy of this Standard Limited Warranty to the Original Owner at the time the product was purchased.

Reseller Name and Address: \_\_\_\_\_  
\_\_\_\_\_

Original Owner Name and Address: \_\_\_\_\_  
\_\_\_\_\_

Accepted Purchase Order No. \_\_\_\_\_

Original Jobsite Address: \_\_\_\_\_  
\_\_\_\_\_

**RESELLER:**

By: \_\_\_\_\_  
Date

Print name and title

4842-7507-8689, v. 1



## Warning

### Water Sensitive Materials - Read this notice carefully

Bundles must be inspected and carrier advised immediately if damage is noted. White rust is a corrosion attack of the zinc coating resulting from the presence of water. Anywhere rust is found will result in a reduction of the life of the galvanized steel.

If water has entered a bundle or if condensation has formed between items, the bundle must be opened, the items separated and all surfaces dried.

#### **If items are to be installed within 10 days:**

Store bundled items off the ground high enough to allow air circulation beneath bundle and to prevent water from entering. Store 1 end at least 8" (20.32cm) higher than the opposite end. Support long bundles in the center. Prevent rain from entering the bundle by covering with a tarpaulin, making provision for air circulation between the draped edges and the ground.

Do not wrap in plastic.

#### **If items are not to be installed within 10 days:**

Provide inside dry storage. Storage beyond 6 months is not recommended. If white rust is apparent upon receipt of shipment, notify Chief immediately. Damage to items, resulting from improper storage, is the responsibility of the receiver.



## Before You Begin

Before starting the installation of the equipment, take time to thoroughly study the construction methods in this manual, this will save you time and money.

Chief makes no warranty concerning components, accessories or equipment not manufactured by Chief.

When using a cutting torch or welding galvanized material, the possibility of developing toxic fumes will exist. Provide adequate ventilation and respiratory protection when using this type of equipment during installation.

### Introduction

Thank you for purchasing Chief equipment. Proper installation and operation will ensure you the best overall experience with your equipment and guarantee smooth operation.

This proprietary information is loaned with the expressed agreement that the drawings and information therein contained are the property of Chief Industries, Inc. and will not be reproduced, copied, or otherwise disposed of, directly or indirectly, and will not be used in whole or in part to assist in making or to furnish any information for the making of drawings, prints or other reproduction hereof, or for the making of additional products or equipment except upon written permission of Chief Industries, Inc. first obtained and specific as to each case. The acceptance of this material will be construed as an acceptance of the foregoing agreement.

The technical data contained herein is the most recent available at the time of publication and is subject to modification without notice. Chief Industries, Inc. reserves the right to modify the construction and method of operation of their products at any time without any obligation on their part to modify any equipment previously sold and delivered.

## General Design Information

All Chief towers are designed for structural support of material handling conveyors and personnel.

All steel materials are purchased in accordance with the applicable ASTM Standard.

All bolted connections are designed using high strength bolts which meet the specifications of the applicable ASTM or SAE standard.

All Chief tower structures are designed to withstand normally anticipated environmental and service conditions per the specified ASCE 7-10 design code.

## Accessory Equipment

All accessory equipment should be installed and maintained in accordance with each individual supplier's installation and operation instructions. However, if any modifications to the Chief standard design are required, contact Chief for special recommendations.

**Important Note:** Do not modify equipment without Chief approval. It is the responsibility of the general contractor to verify that all equipment is properly installed and that the equipment is compatible with the intended use. A qualified electrician should be contracted to complete all electrical wiring and servicing.

## General Contractor Responsibilities

It is the responsibility of the general contractor to verify that the complete support system and other accessory equipment is constructed with quality workmanship and that all equipment is installed per the respective manufacturer's instructions.

In addition, the general contractor is responsible for the fitness of use of any system which he constructs. All accessory equipment incorporated into the system should be approved for the intended use by each respective equipment manufacturer.

## Field Modifications and Installation Defects

Chief assumes no responsibility for field modifications or installation defects which result in structural damage. If any field modifications are necessary which are not specifically covered by the contents of the installation manual, contact Chief for approval. Any unauthorized modification or installation defect which affects the structural integrity of the support system will void the warranty.

## Checking Shipment

For your convenience steel components will be color coded, individual items labeled with an appropriate part number and packages labeled. Hardware, including bolts, nuts, screws and other small clips or brackets may be divided into smaller packages for ease of use and identification.

Check your shipment at the time of delivery against the packing list provided with the shipment. If any items are missing or any damaged material is evident, note such shortage or damage on the freight bill before you sign the shipment paperwork.

Claims of shortages will not be honored after 30 days from receipt of shipment. Parts that are missing or damaged are the responsibility of the delivering carrier, not the manufacturer or dealer.

It is advisable to reorder damaged or missing parts immediately so that there will be no delay in the bin installation. After receiving the invoice for the reordered material, file a claim with the delivering carrier immediately.

## Suggested Equipment

Chief recommends the following equipment and tools needed for installation of the grain storage bin. Individual installations may vary.

- Impact wrenches and sockets
- End wrenches
- Crescent wrenches
- Vise grip pliers
- Alignment punches
- Rubber mallets
- Level

## Hardware Torque

All components are assembled using SAE grade hex head bolts with corresponding washers and nuts. Bolts are marked with radial lines on the bolt head as shown in the following illustration.

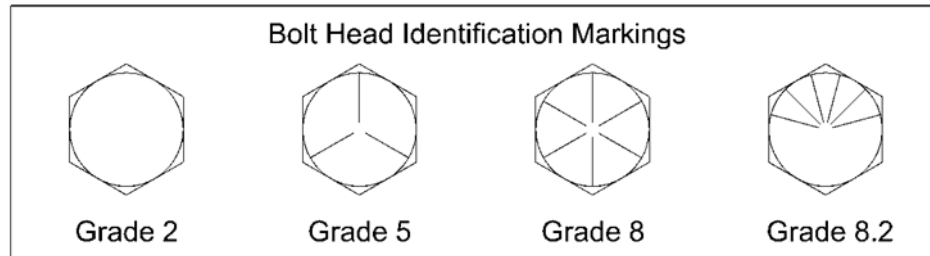

**Do not substitute any other bolt type or grade. Use only the bolts supplied by Chief. The substitution of bolts from other sources is not permitted and will void the warranty.**

When installing hardware the minimum and maximum torque values shown below must be followed. All hardware must seat tight against the corresponding bin component.

Bolt Diameter	Grade 2	Grade 5	Grade 8	Grade 8.2
<b>1/4" (.63cm)</b>	6 ft.-lbs.	10 ft.-lbs.	14 ft.-lbs.	14 ft.-lbs.
<b>5/16" (.79cm)</b>	12 ft.-lbs.	19 ft.-lbs.	29 ft.-lbs.	29 ft.-lbs.
<b>3/8" (.95cm)</b>	20 ft.-lbs.	25 ft.-lbs.	47 ft.-lbs.	47 ft.-lbs.
<b>3/4" (1.90cm)</b>	155 ft.-lbs.	240 ft.-lbs.	380 ft.-lbs.	380 ft.-lbs.
<b>1" (2.54cm)</b>	-	-	910 ft.-lbs.	-

Please note the following wrench / socket size to be used on the corresponding hardware:

Bolt Size	Head Size	Nut Size
<b>1/4" (.63cm)</b>	7/16" wrench	7/16" wrench
<b>5/16" (.79cm)</b>	1/2" wrench	1/2" wrench
<b>3/8" (.95cm)</b>	9/16" wrench	9/16" wrench
<b>3/4" (1.90cm)</b>	1-1/8" wrench	1-1/8" wrench
<b>1" (2.54cm)</b>	1-1/2" wrench	1-1/2" wrench

# Installation

## Part Identification

The following is a general outline provided for reference only.

**Important Note:** Prior to starting the installation it is very important to plan ahead and by verifying the order and location of all components.

**Important Note:** Leave all hardware loose until all components have been added. This will allow for proper alignment of components and ensure that tolerances do not accumulate.

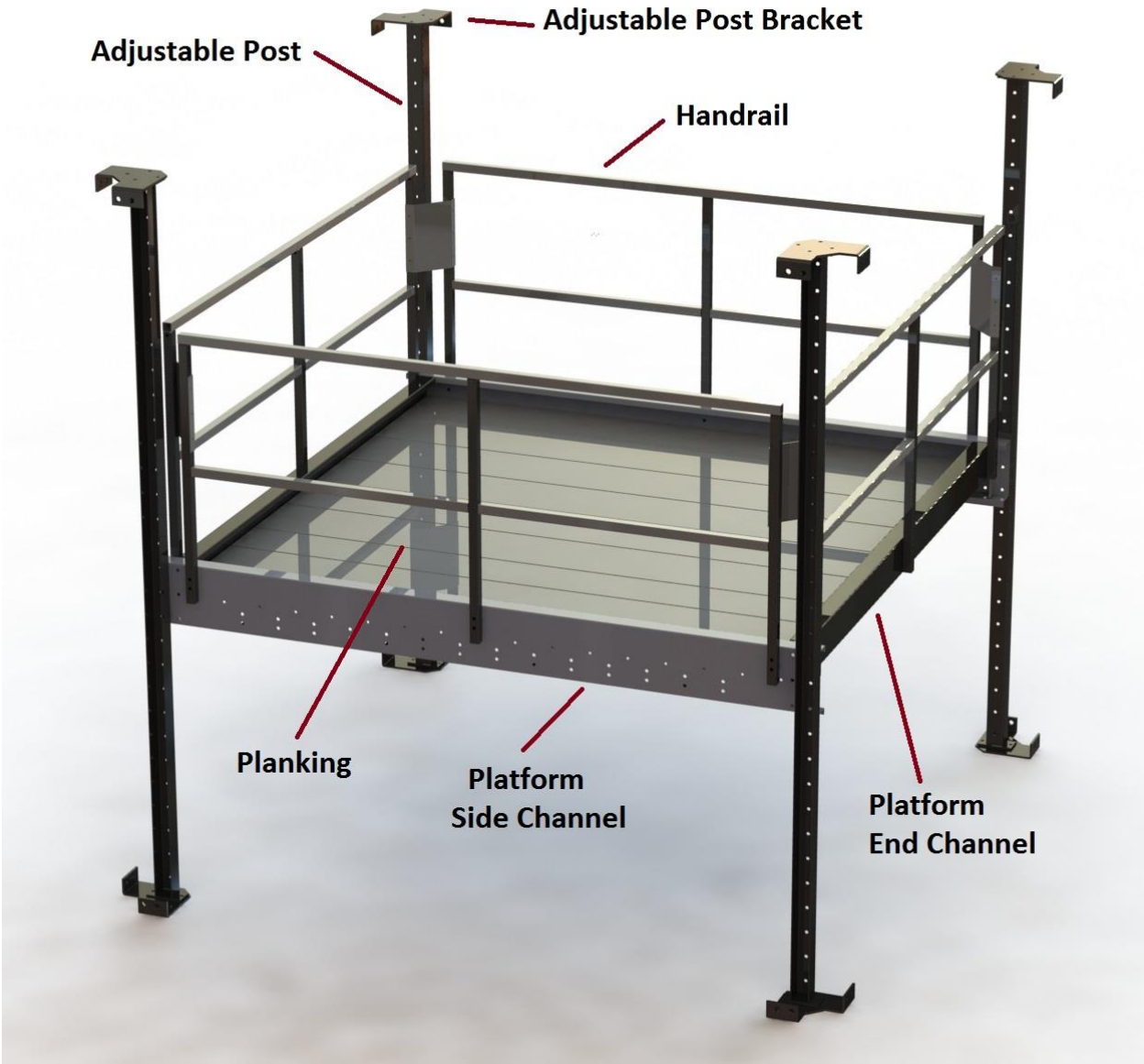

**Side Channel**

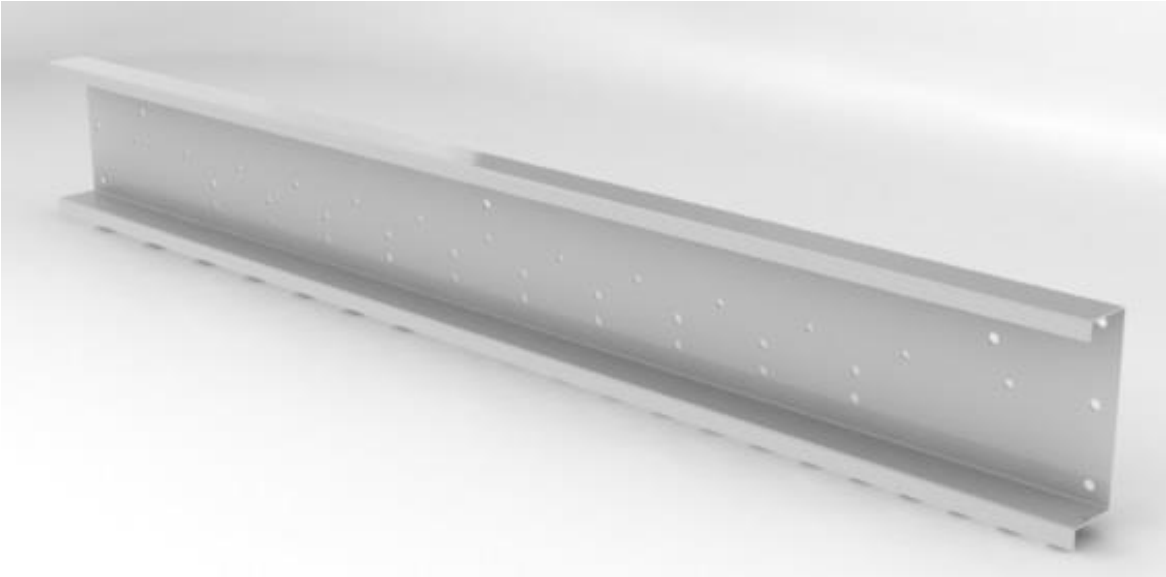

<b>Tower Width</b>	<b>Single Pc.</b>	<b>Pc "A"</b>	<b>Pc "B"</b>
6' (1.82m)	9623490		
8' (2.43m)	9621869	-	-
10' (3.04m)	9621855	-	-
12' (3.65m)	9621149	-	-
14' (1.21m)	-	9621155	9621171
16' (1.82m)	-	9621162	9621553



**End Channel**



<b>Tower Width</b>	<b>Single Pc.</b>	<b>Pc "A"</b>	<b>Pc "B"</b>
6' (1.82m)			
8' (2.43m)	9621868	-	-
10' (3.04m)	9621856	-	-
12' (3.65m)	9621148	-	-
14' (1.21m)	-	9621154	9621170
16' (1.82m)	-	9621159	9621552

**Floor Brace**

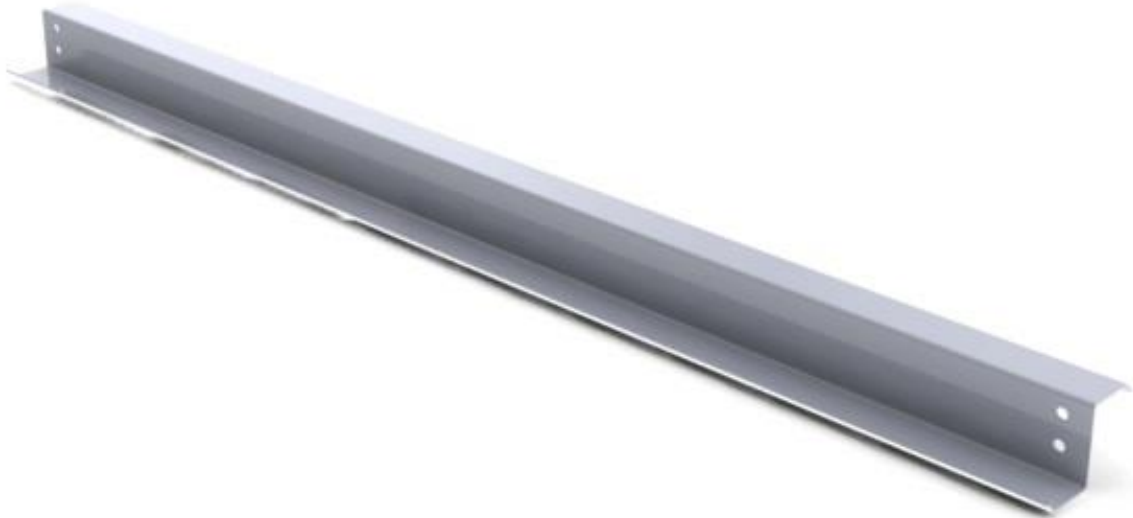

<b>Tower Width</b>	<b>Single Pc.</b>	<b>Pc "A"</b>	<b>Pc "B"</b>
6' (1.82m)			
8' (2.43m)	9621870	-	-
10' (3.04m)	9621858	-	-
12' (3.65m)	9621150	-	-
14' (1.21m)	-	9621156	9621566
16' (1.82m)	-	9621163	9621567

### Floor Planking



<b>Tower Width</b>	<b>12" Width</b>	<b>9" Width</b>
6' (1.82m)	9623492	9623491
8' (2.43m)	9621862	9621872
10' (3.04m)	9621860	9621861
12' (3.65m)	9621152	9621153
14' (4.27m)	431884	431883
16' (4.88m)	431884	431883

**Channel Clip**

9621857



**Floor Brace Clip**

9621859



**Adjustable Post Bracket**

9621851

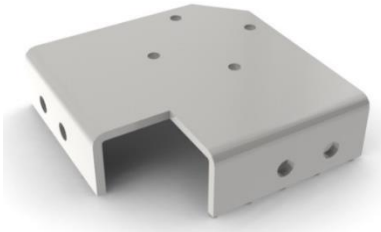

**Adjustable Post Bracket**

- 9621854      10' (3.04m)
- 9623685      6' (1.82m)
- 9623515      4' (1.21m)



**Handrail**

- 9623495 6' (1.82m)
- 9621874 8' (2.43m)
- 9621863 10' (3.04m)
- 9621516 12' (3.65m)
- 9621634 14' (4.27m)
- 9621655 16' (4.88m)



**Side Channel Splice**

9621554



**End Channel Splice**

9621555



## Floor Brace Splice

9621570



## Hardware Packages

- 8' 9621877
- 10' 9621867
- 12' 9621662
- 14' 9621663
- 16' 9621664

### Platform Layouts

8' x 8' (2.43m x 2.43m) Internal Platform.

- 9621868 End Channel
- 9621869 Side Channel
- 9621870 Floor Brace
- 9621862 Plank 12"
- 9621872 Plank 9"

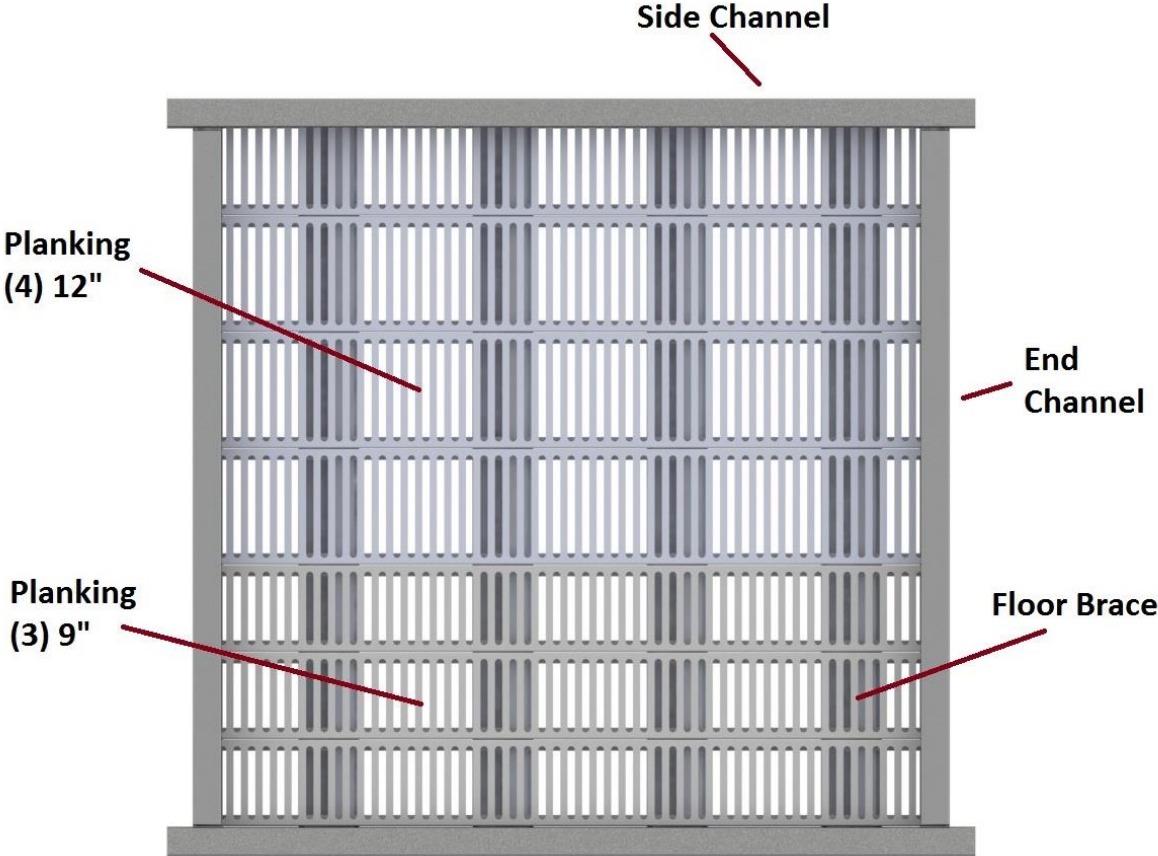

INTERNAL PLATFORM

10' x 10' (3.04m x 3.04m) Internal Platform.

- 9621856 End Channel
- 9621855 Side Channel
- 9621858 Floor Brace
- 9621860 Plank 12"
- 9621861 Plank 9"

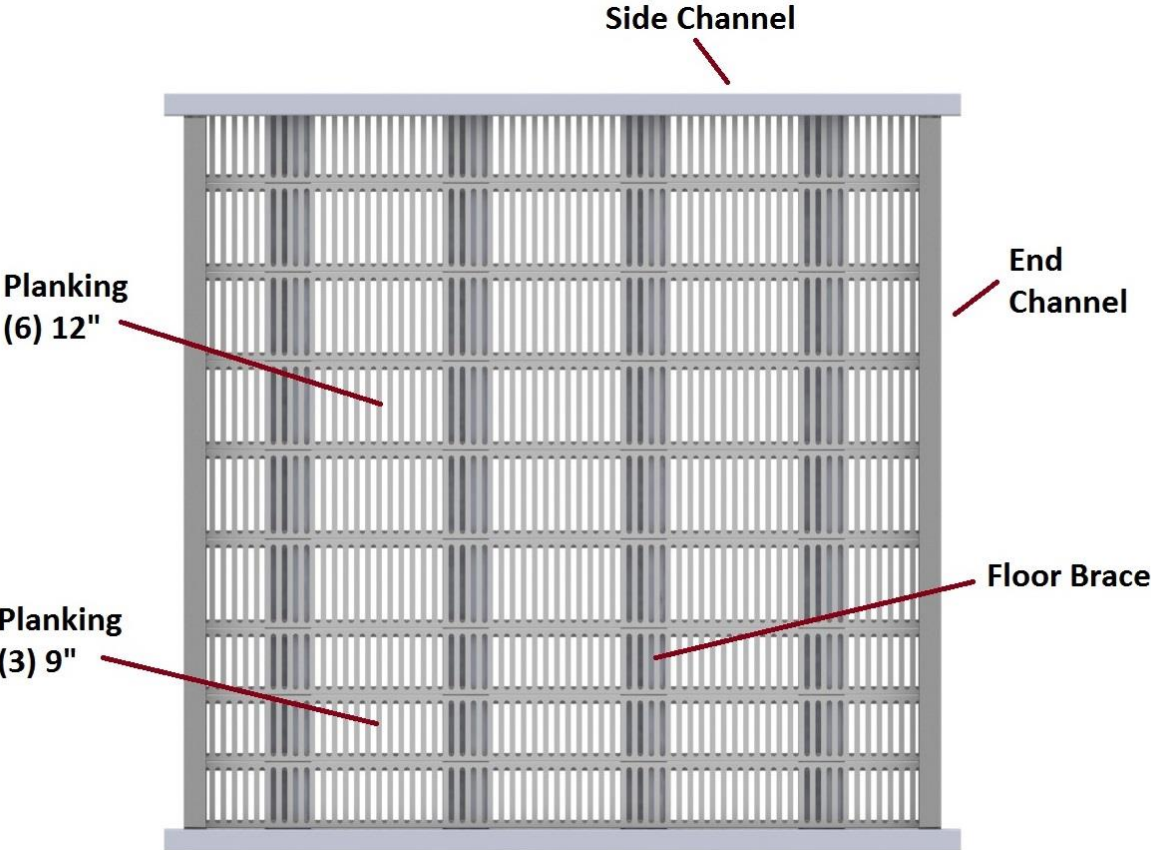



INTERNAL PLATFORM

12' x 12' (3.65m x 3.65m) Internal Platform.

- 9621148 End Channel
- 9621149 Side Channel
- 9621150 Floor Brace
- 9621152 Plank 12"
- 9621153 Plank 9"

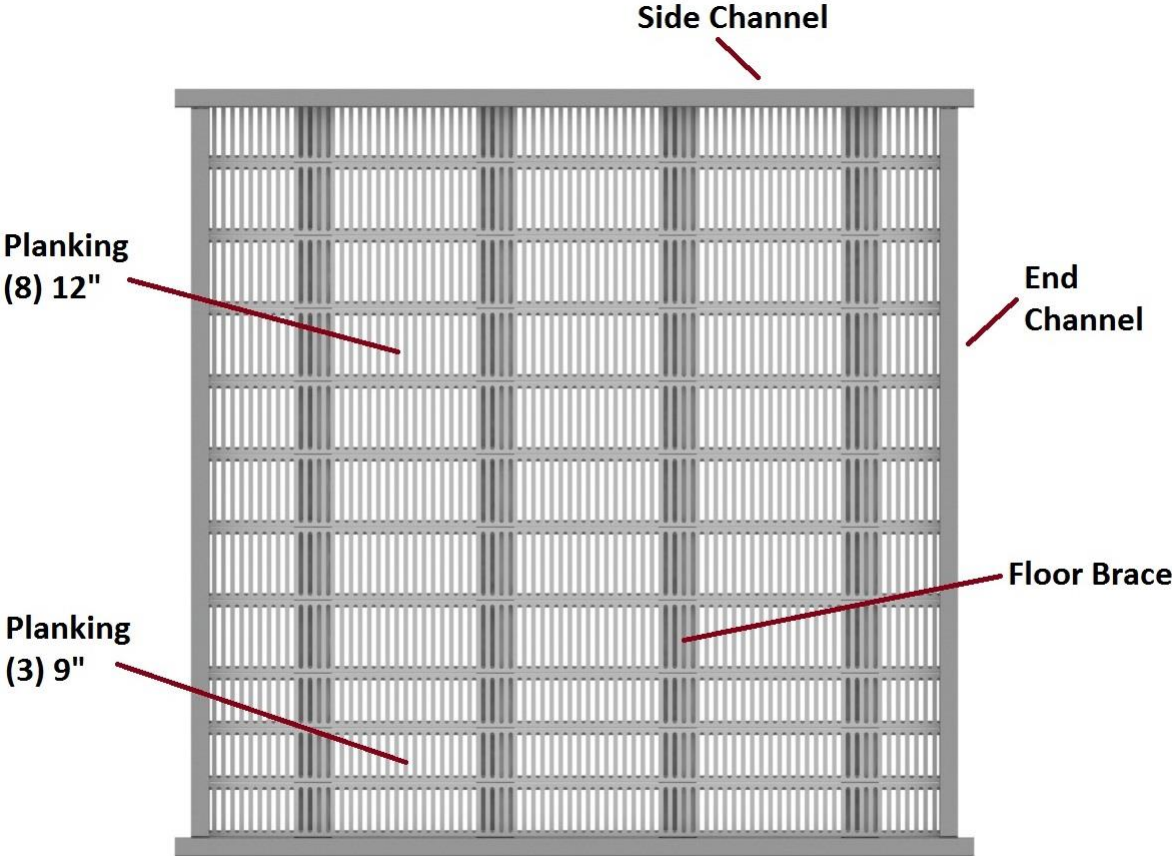

INTERNAL PLATFORM

14' x 14' (4.26m x 4.26m) Internal Platform.

- 9621154 End Channel #1
- 9621170 End Channel #2
- 9621555 End Channel Splice
- 9621171 Side Channel #1
- 9621155 Side Channel #2
- 9621554 Side Channel Splice
- 9621566 Floor Brace
- 431884 Plank 12"
- 431883 Plank 9"

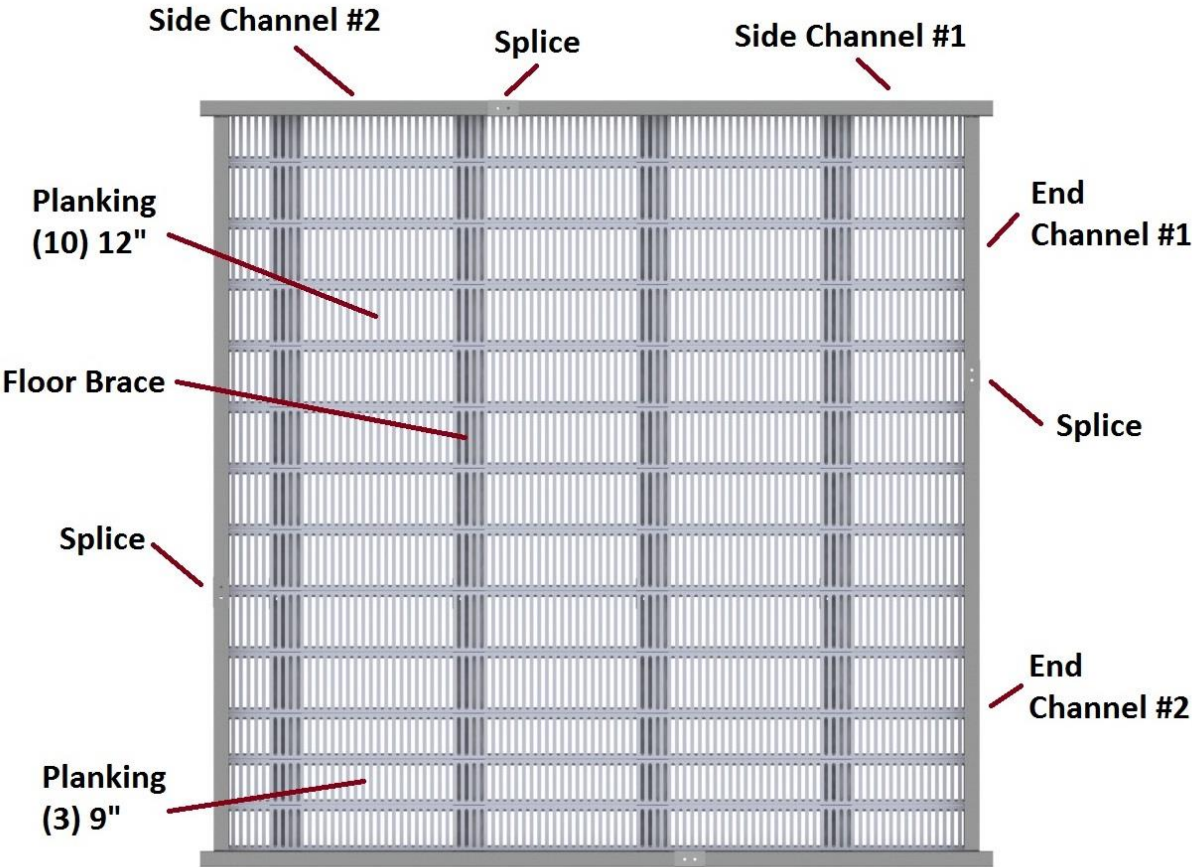

INTERNAL PLATFORM

16' x 16' (4.87m x 4.87m) Internal Platform.

- 9621159 End Channel #1
- 9621552 End Channel #2
- 9621555 End Channel Splice
- 9621553 Side Channel #1
- 9621162 Side Channel #2
- 9621554 Side Channel Splice
- 9621567 Floor Brace
- 431884 Plank 12"
- 431883 Plank 9"

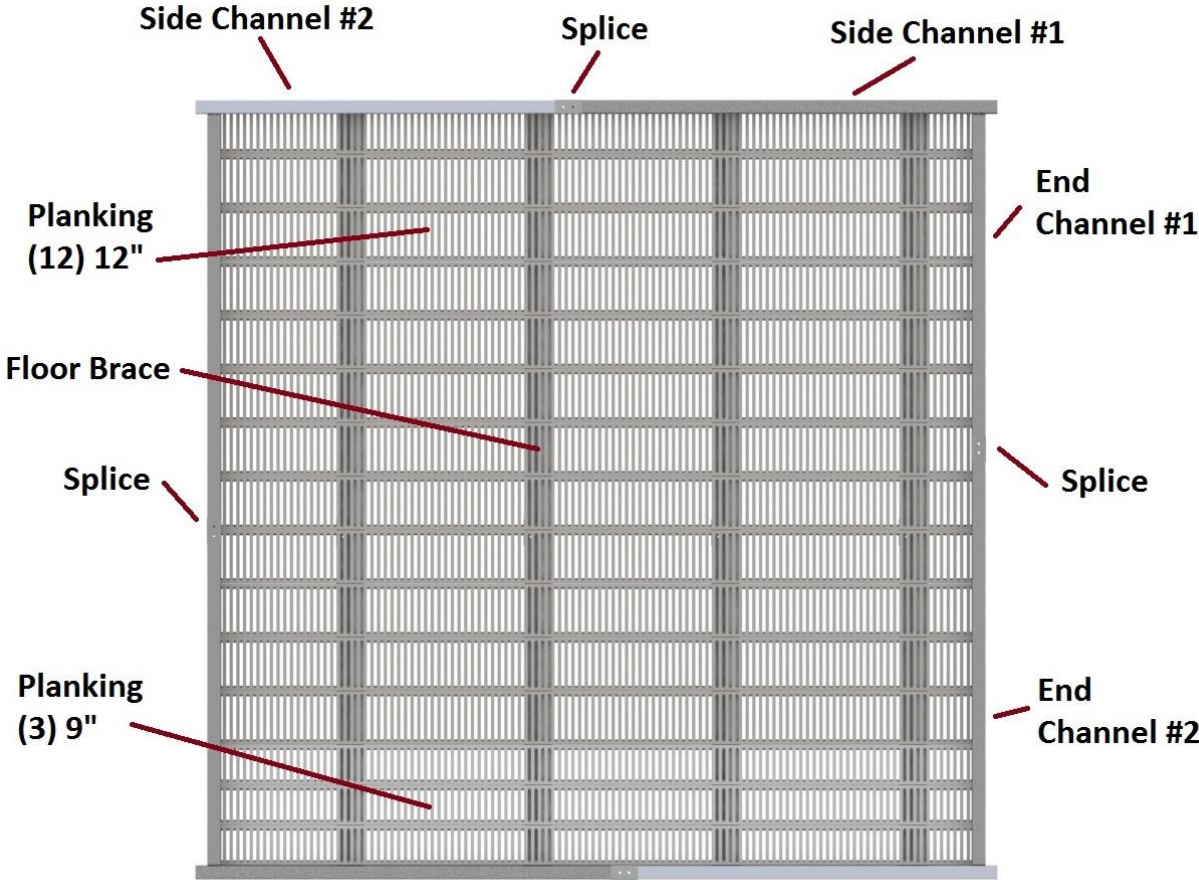

Determine which leg option will best suit the application. Floor bracing is to be positioned so as not to interfere with elevator legs and cannot be cut to fit. The floor bracing location can be adjusted in increments of 6.00" (15.24cm). If no elevator leg is required, equally space floor bracing in channel frame.

- Single Leg Option



- Double Leg Option



- Large Leg Option

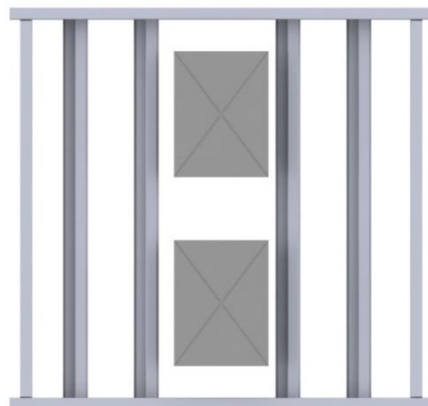

## Installation

Place side channels with ledge facing inward and ledge lip facing down.

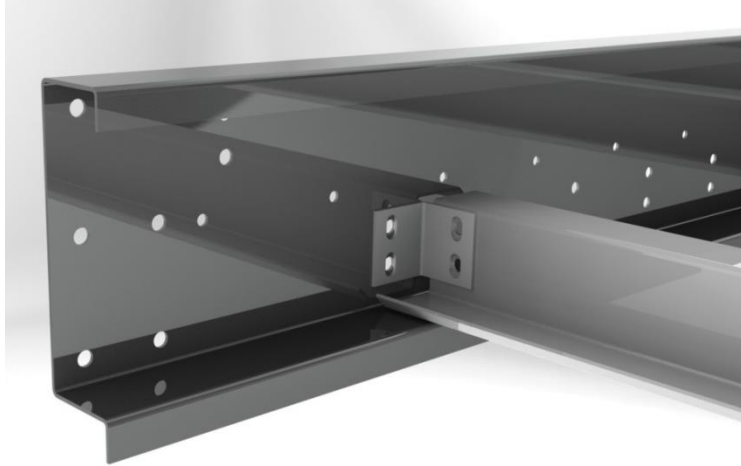

14' (4.26m) and 16' (4.87m) side channels require a bolted splice plate on the exterior of the side channel splice line. These connections will require 1/2" x 1-1/2" (1.27cm x 3.81cm) Grade 5 bolts with lock washer and nut. Bolt heads are to be located to the exterior of the platform.

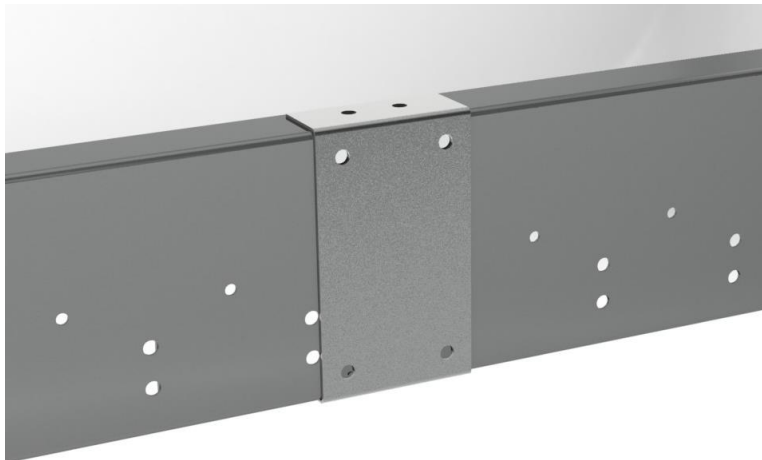

Bolt the floor bracing clips to the floor braces. These connections will require 1/2" x 1-1/2" (1.27cm x 3.81cm) Grade 5 bolts with lock washer and nut.

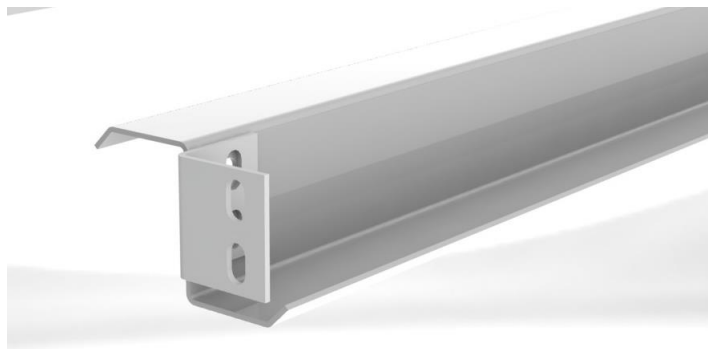

## INTERNAL PLATFORM

14' (4.26m) and 16' (4.87m) floor braces require a bolted splice plate on the bottom of the floor brace splice line. These connections will require 1/2" x 1-1/2" (1.27cm x 3.81cm) Grade 5 bolts with lock washer and nut.

**Important Note:** To allow the floor planks to rest flush with the top surface of the floor brace, the splice plates must be located and attached below the floor brace.

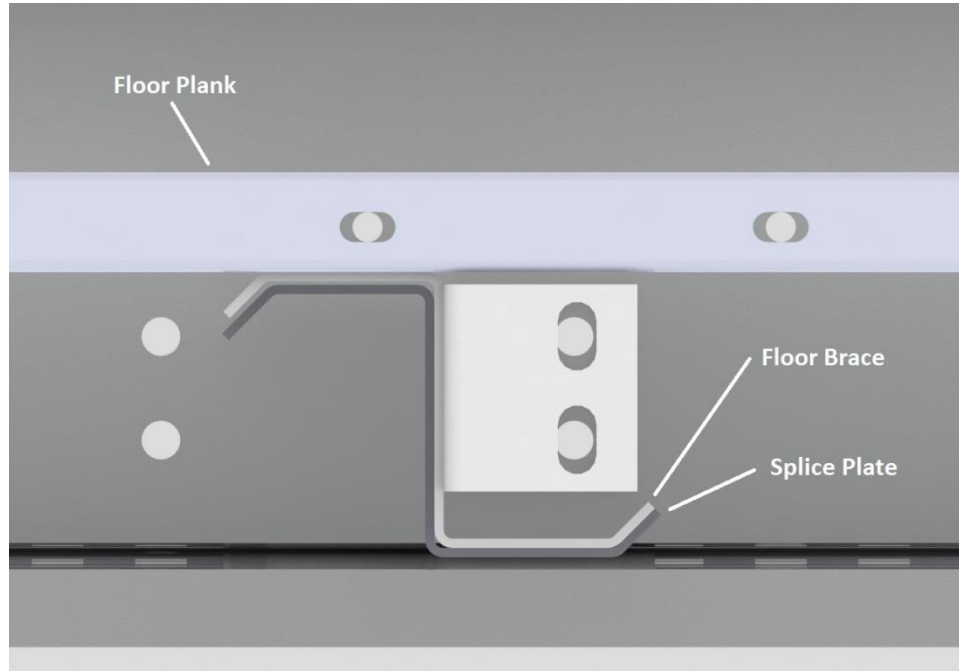

Position the floor bracing so as to not interfere with elevator leg. Bolt the floor bracing clips on the floor braces to the side channels. These connections will require 1/2" x 1-1/2" (1.27cm x 3.81cm) Grade 5 bolts with lock washer and nut.

**Important Note:** Verify that floor brace spacing does not exceed 36" (91.44cm).



## INTERNAL PLATFORM

Place planking on floor braces, parallel with side channels and perpendicular to the floor braces.

**Important Note:** It may be helpful to preassemble one end channel at this time to assist in the correct positioning of the floor planking and assure the correct overlap of the floor planks on the end channels.

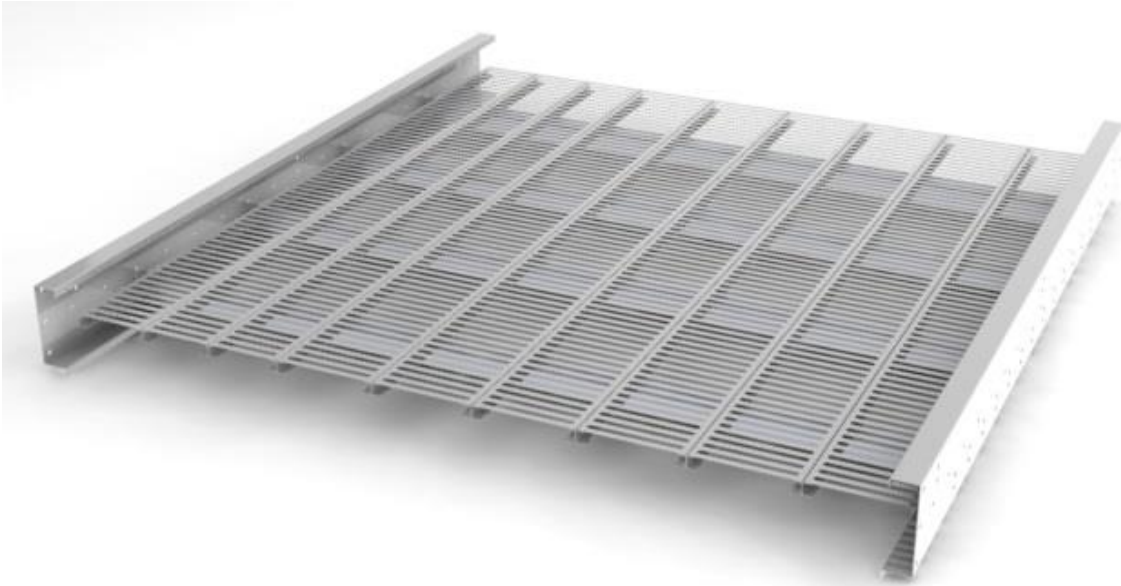

Bolt planking first to side channel and then successive planks to each other. These connections will require 3/8" x 1" (.95cm x 2.54cm) Grade 5 bolts with lock washer and nut.

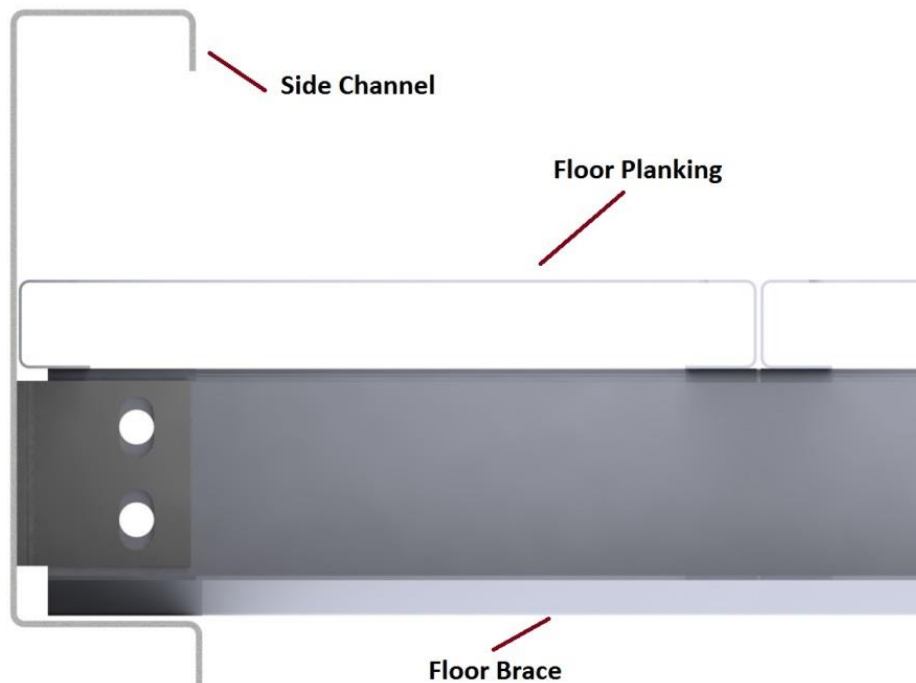



## INTERNAL PLATFORM

When positioned correctly there will be approximately 2-1/2" (6.35cm) minimum overlap on each end of the floor planking resting on the end channel frame. Floor planks must rest on the end channel ledge to provide adequate support. When positioned correctly there will be an approximate gap of 1/4" (.63cm) between edge of plank and the face of the end channel.

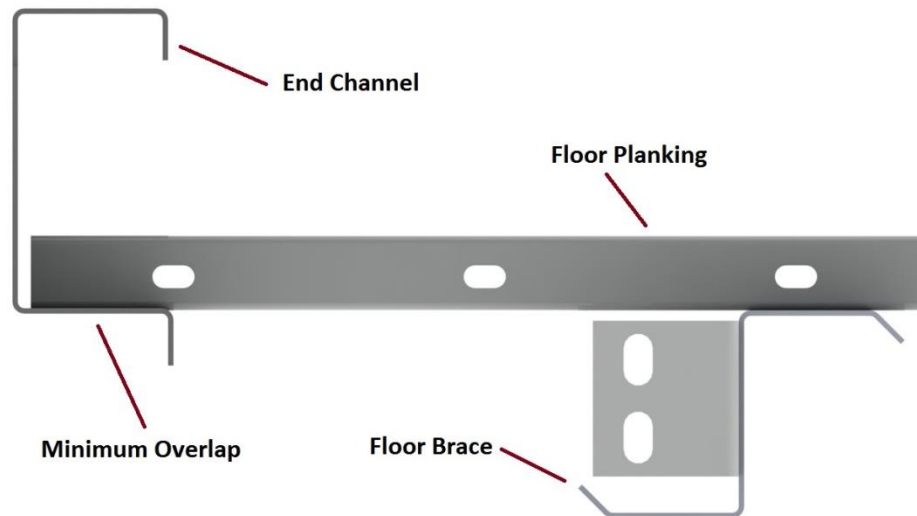

After positioning the floor planking correctly, screw the bottom side of the planking to the floor bracing using #10 self-drilling TEK screws as needed. On average each plank will require 4 screws equally spaced along each flange. Planking is to be field cut and positioned as required.

Splicing planking to accommodate equipment or extended lengths of planking is acceptable. Each splice joints is to be fastened through the bottom plank flange with #10 self-drilling TEK screws at each end as shown in the following illustration. Floor braces can be spaced up to but not exceeding 36" (91.44cm) apart. This spacing ensures compliance with loading and deflection requirements

**Important Note:** Verify the following:

- Splice joints are located and centered above a floor brace.
- Planking is supported on both ends.
- Floor brace spacing.

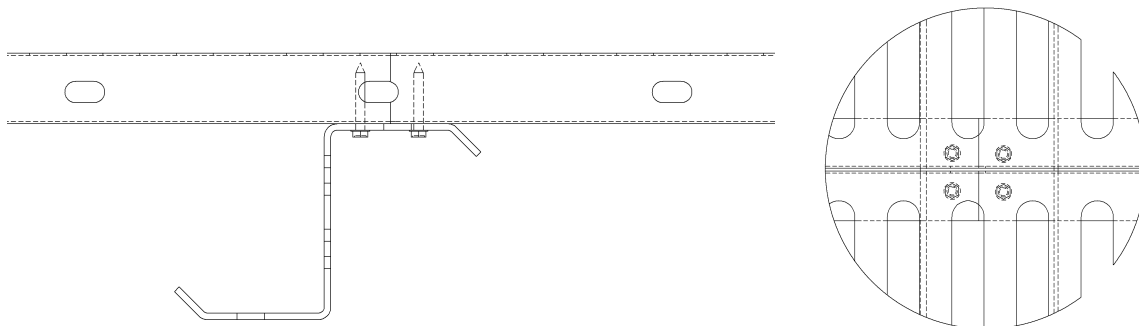



Typical full plank lengths should be adjusted to match floor brace locations and project specific requirements:

A typical plank layout is shown for reference in the following illustration.

**Important Note:** Verify lengths of all planks after elevator leg is located.

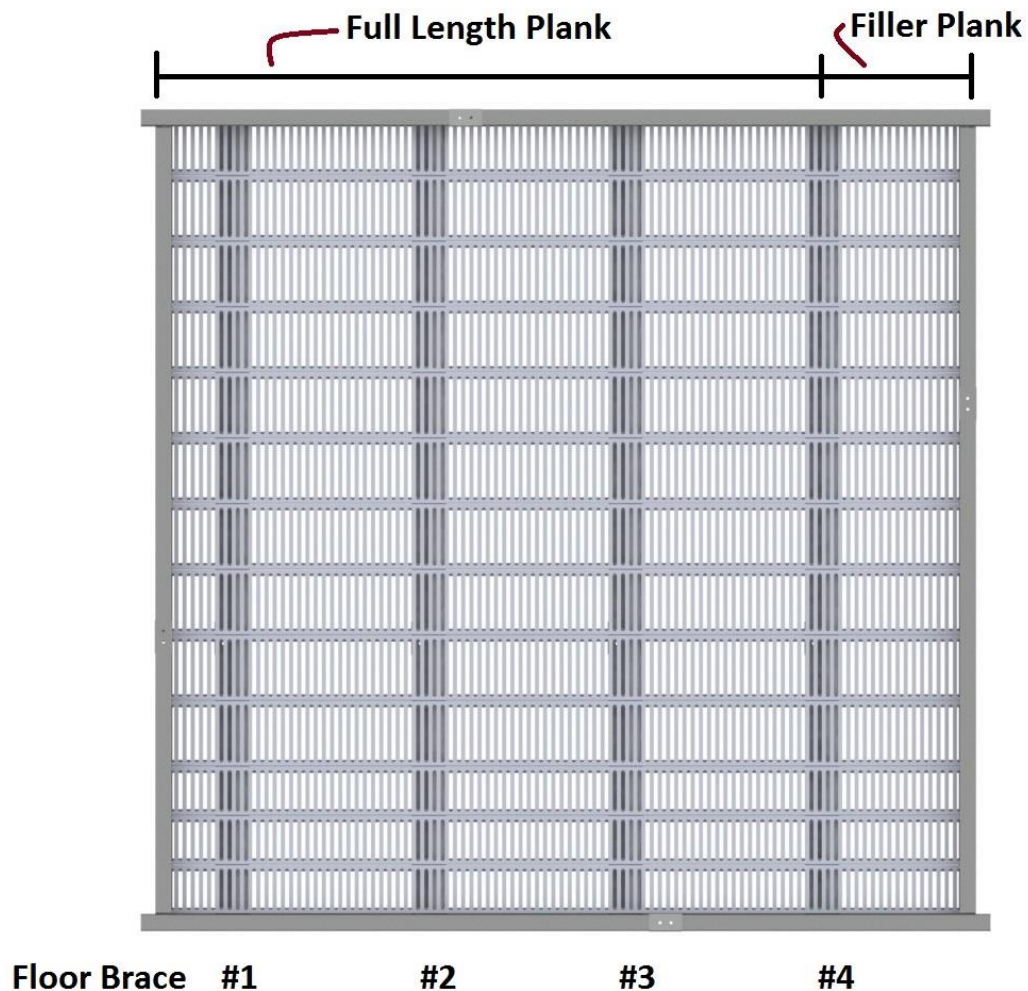

Typical lengths when elevator legs are not required are shown below:

- 8' x 8' (2.43m x 2.43m) bay full plank length = 77.50" (196.85cm)
- 10' x 10' (3.04m x 3.04m) bay full plank length = 101.50" (257.81cm)
- 12' x 12' (3.65m x 3.65m) bay full plank length = 125.50" (318.77cm)
- 14' x 14' (4.26m x 4.26m) bay full plank length = 123.00" (312.42cm)
- 14' x 14' (4.26m x 4.26m) bay filler plank length = 26.50" (67.31cm) – splice line on floor brace #4
- 16' x 16' (4.87m x 4.87m) bay full plank length = 141.00" (358.14cm)
- 16' x 16' (4.87m x 4.87m) bay filler plank length = 32.50" (82.55cm) – splice line on floor brace #4

## INTERNAL PLATFORM

Bolt the channel clips to the end channel and fasten the end channel to the side channel. These connections will require 1/2" x 1-1/2" (1.27cm x 3.81cm) Grade 5 bolts with lock washer and nut.



**Important Note:** Verify the orientation of the clips. The toe of the 5 slot clip is to the interior of the internal platform. Verify that the top of all channel frame pieces are flush along the top surface.



## INTERNAL PLATFORM

14' (4.26m) and 16' (4.87m) end channels require a bolted splice plate on the exterior of the end channel splice line. These connections will require 1/2" x 1-1/2" (1.27cm x 3.81cm) Grade 5 bolts with lock washer and nut. Bolt heads are to be located on the exterior of the platform.



Install the adjustable posts inside the tower bay. Bolt the adjustable post mounting bracket on the tower column posts.

**Important Note:** This bracket is mounted to the inside of the post ear plates and below the post end plate.

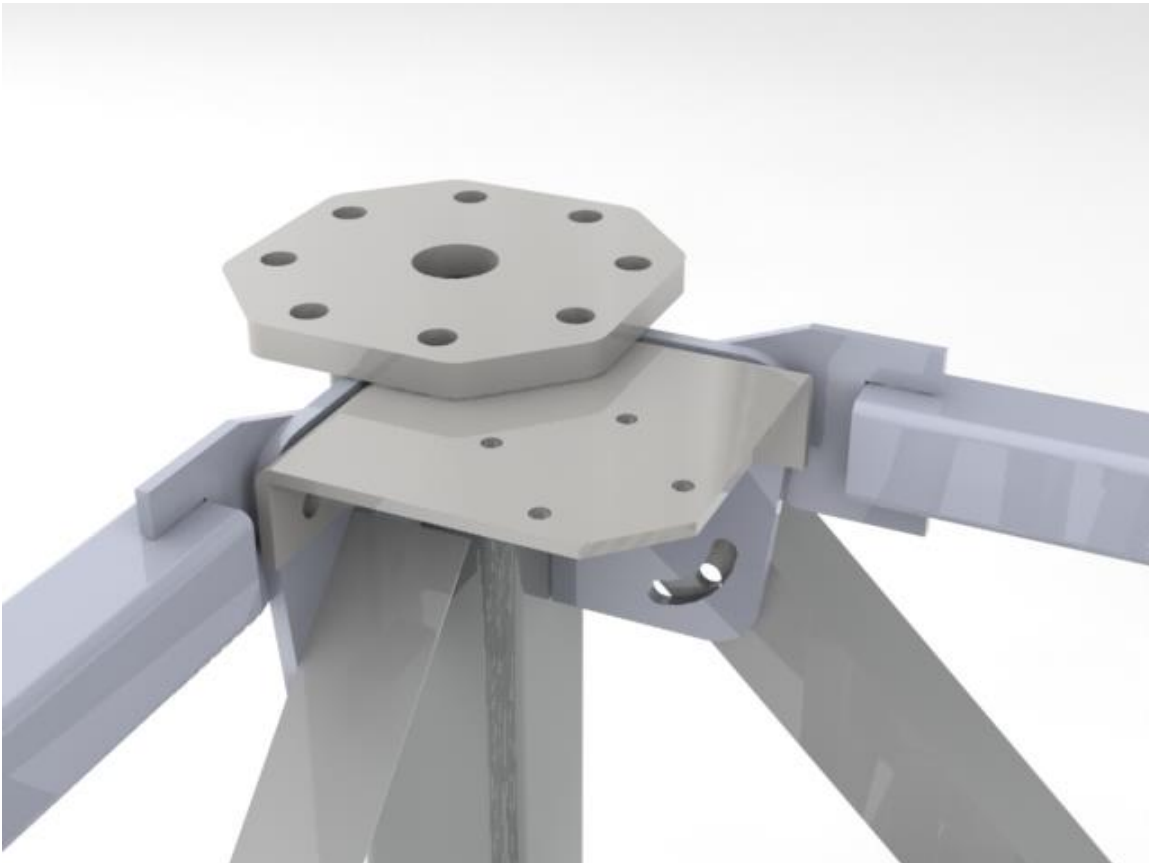

## INTERNAL PLATFORM

Align the single row of holes along the length of the adjustable post to the mounting holes in the side channel and bolt the adjustable post to the bracket. These connections will require 1/2" x 1-1/2" (1.27cm x 3.81cm) Grade 5 bolts with lock washer and nut.

Adjust the height of the internal platform as required by your application. Bolt the internal platform side channels to the adjustable post. These connections will require 1/2" x 1-1/2" (1.27cm x 3.81cm) Grade 5 bolts with lock washer and nut.

**Important Note:** Verify the internal platform base is level and square inside the tower bay.

Bolt on the handrail to the internal platform channel sides. These connections will require 1/2" x 2-1/2" (1.27cm x 6.35cm) Grade 5 bolts with lock washer and nut.



## INTERNAL PLATFORM

Position the handrail reinforcement strap across the end of the safety handrail to enclose and reinforce the corners. Fasten the strap to the handrail with (3) #10 self-drilling TEK screws on each side as required.



## Elevator Leg Framing

Installation of elevator legs will require framing and additional components, such as kick plates and handrails, to be fabricated to meet safety regulations. These components are to be fabricated and supplied by the builder.

**Important Note:** Angle toe board around perimeter of elevator leg opening must be 4" (10.16cm) height minimum. Handrail guard must be 2 x 2 x 3/16" (5.08cm x 5.08cm x .47cm) minimum.

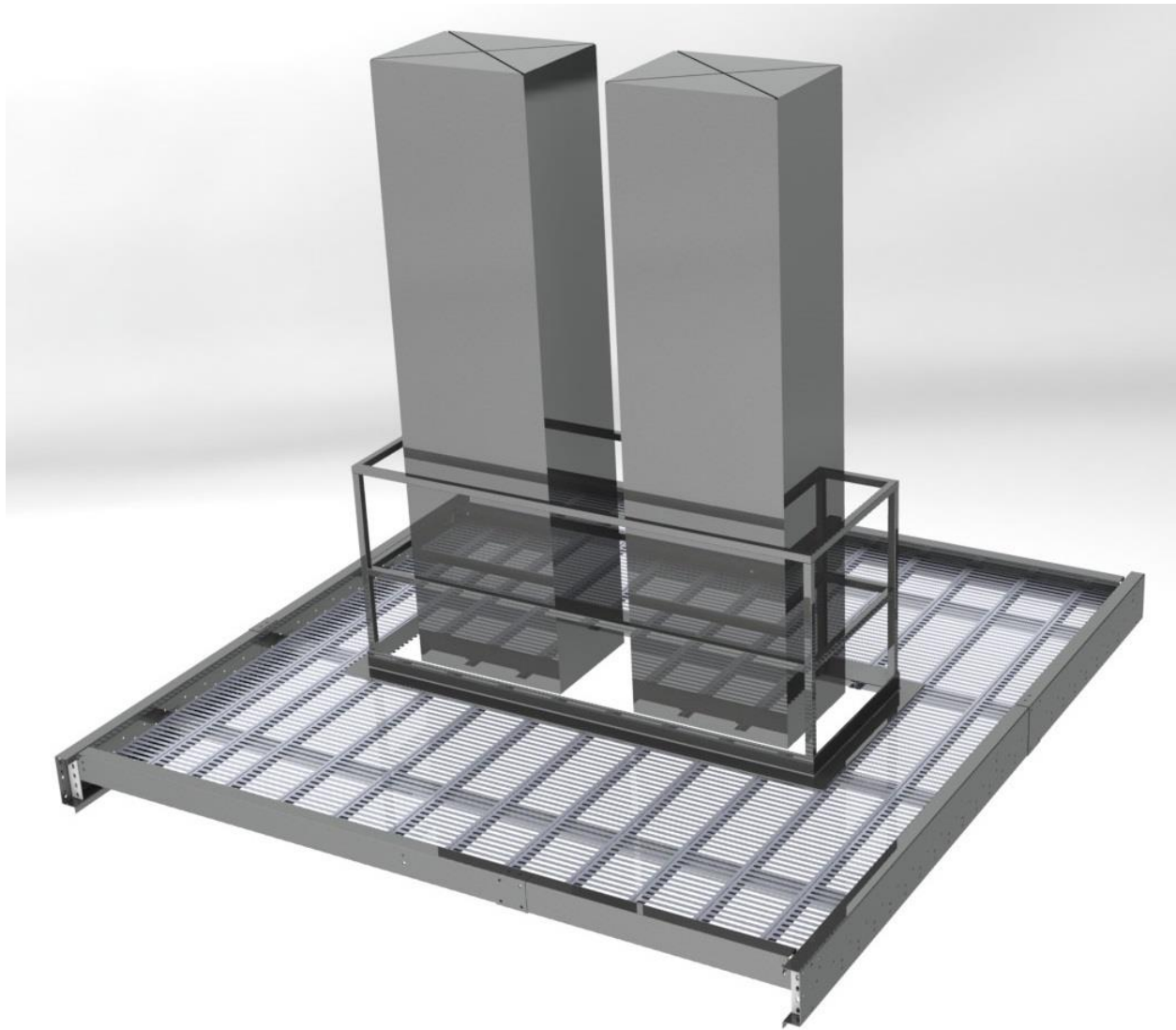

## Maintenance Instructions

An annual inspection of the structure should be made to verify bolts are tight and torque recommendation maintained. Re-tighten hardware as required.





Should you have any questions concerning assembly instructions, parts or drawings, please feel free to contact us at any of the following.

© Chief Industries, Inc. Inc.  
4400 East 39<sup>th</sup> Street • PO Box 848  
Kearney, NE 68847  
Phone 800.359.7600

For more information about Chief Industries, Inc. and additional products or services visit our website  
[www.agri.Chiefind.com](http://www.agri.Chiefind.com)